

UPPER EAST SIDE  
**UNIONVILLE**

**SUMMIT**  
ELEV A • 3009 SQ. FT.  
ELEV B • 3006 SQ. FT.

**A** FLANKAGE

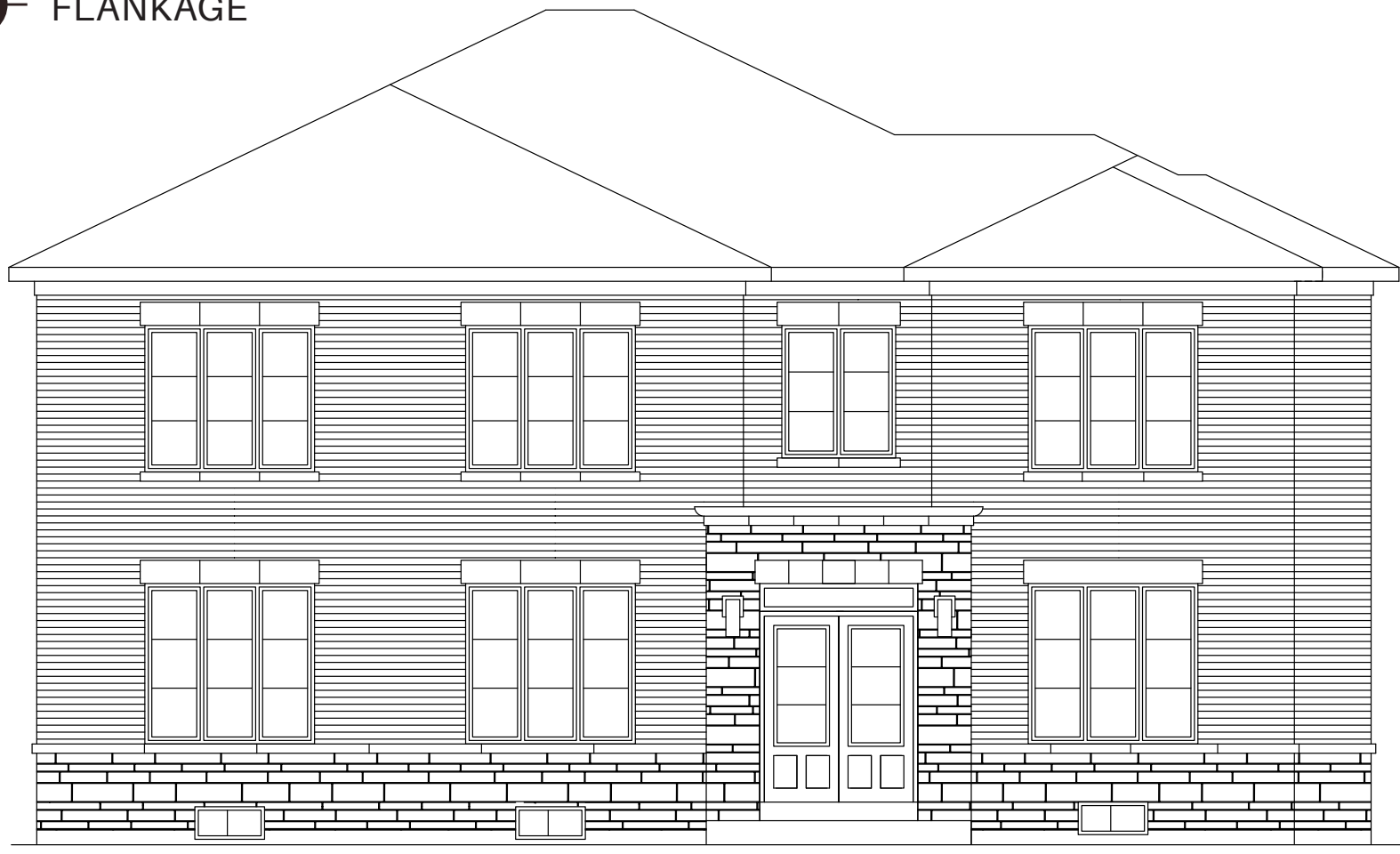

ARTIST CONCEPT

**B** FLANKAGE



ARTIST CONCEPT

45'

FIELDGATEHOMES.COM



UPPER EAST SIDE  
**UNIONVILLE**

UPPER EAST SIDE  
**UNIONVILLE**

**SUMMIT**  
ELEV A • 3009 SQ. FT.  
ELEV B • 3006 SQ. FT.

**B**



ARTIST CONCEPT

**A**



ARTIST CONCEPT

45'

FIELDGATEHOMES.COM



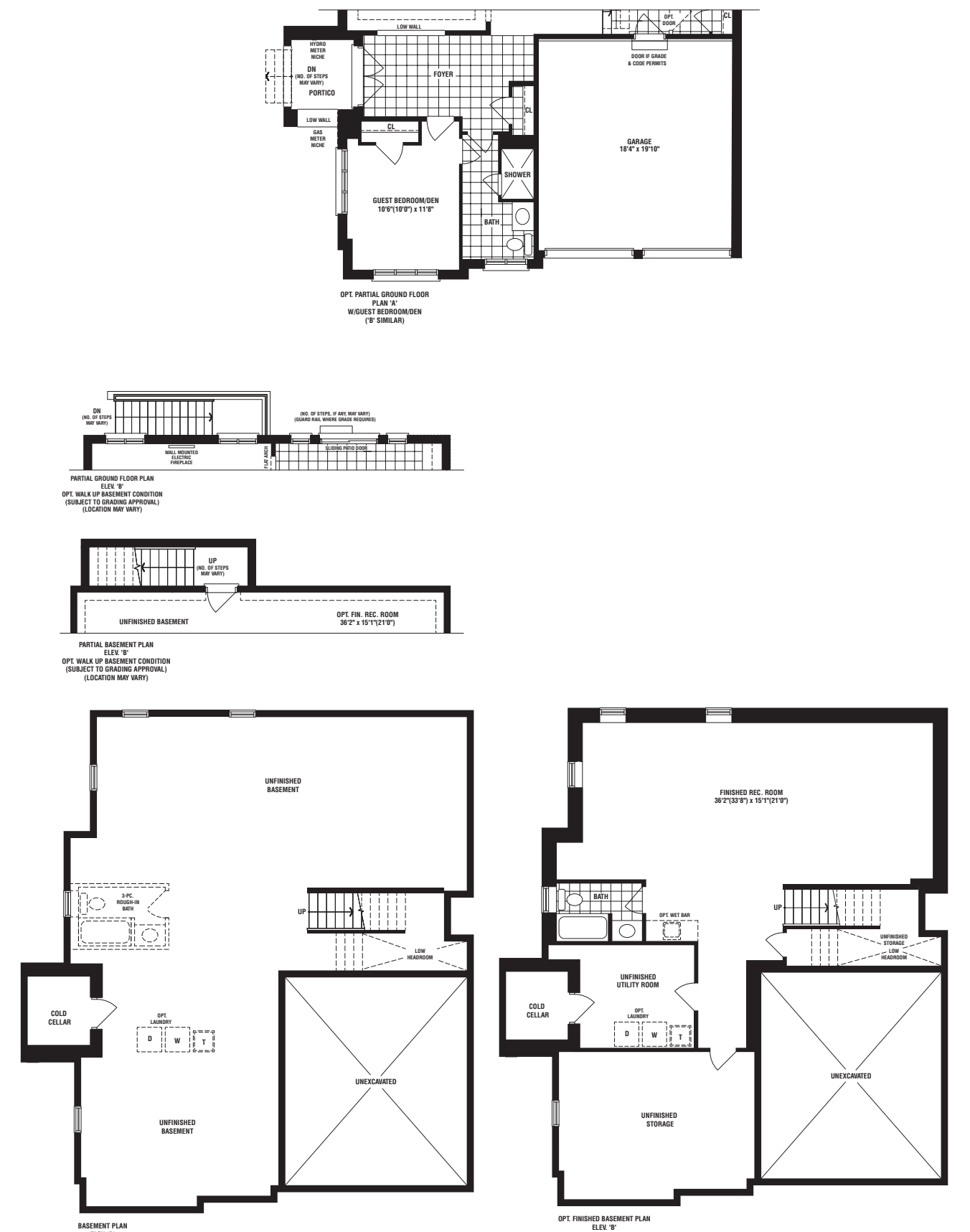
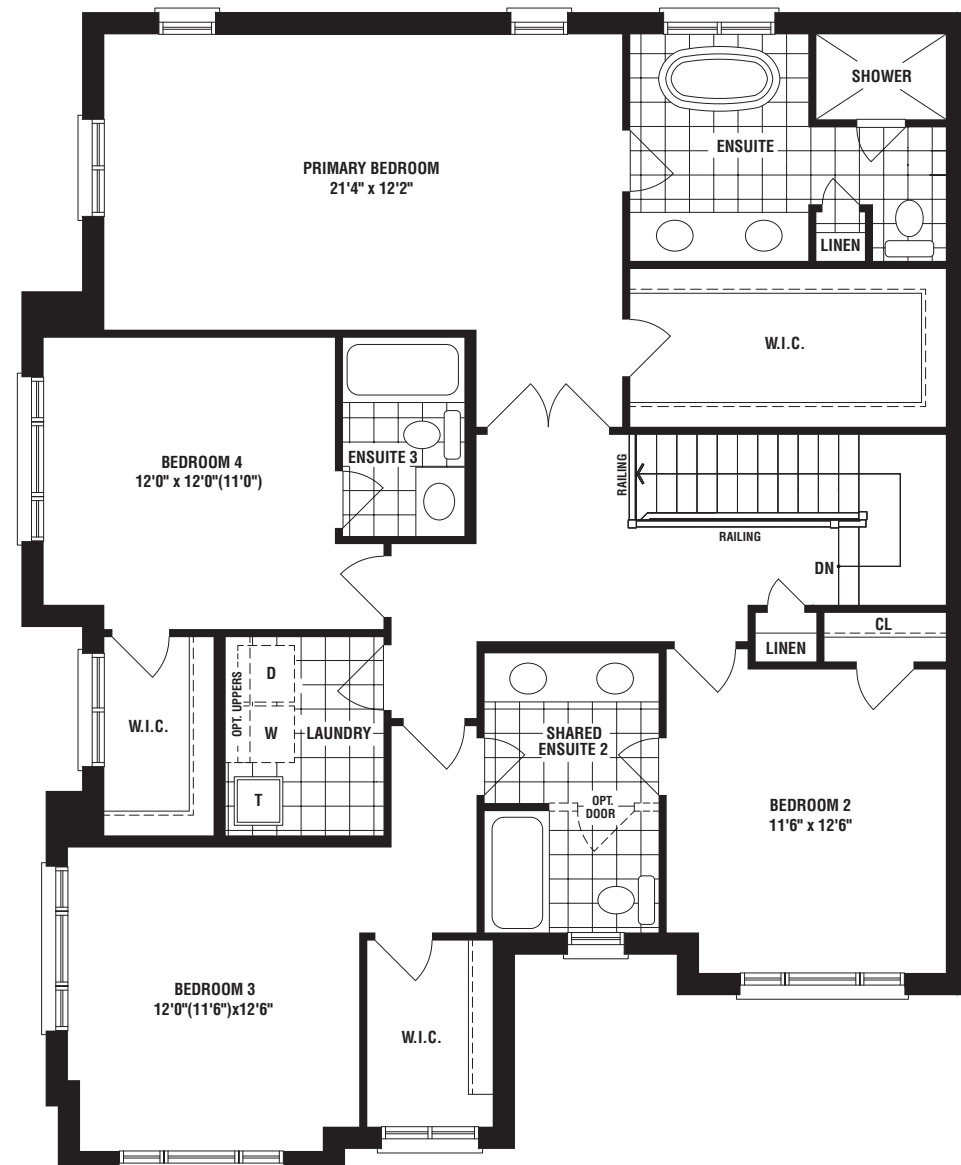
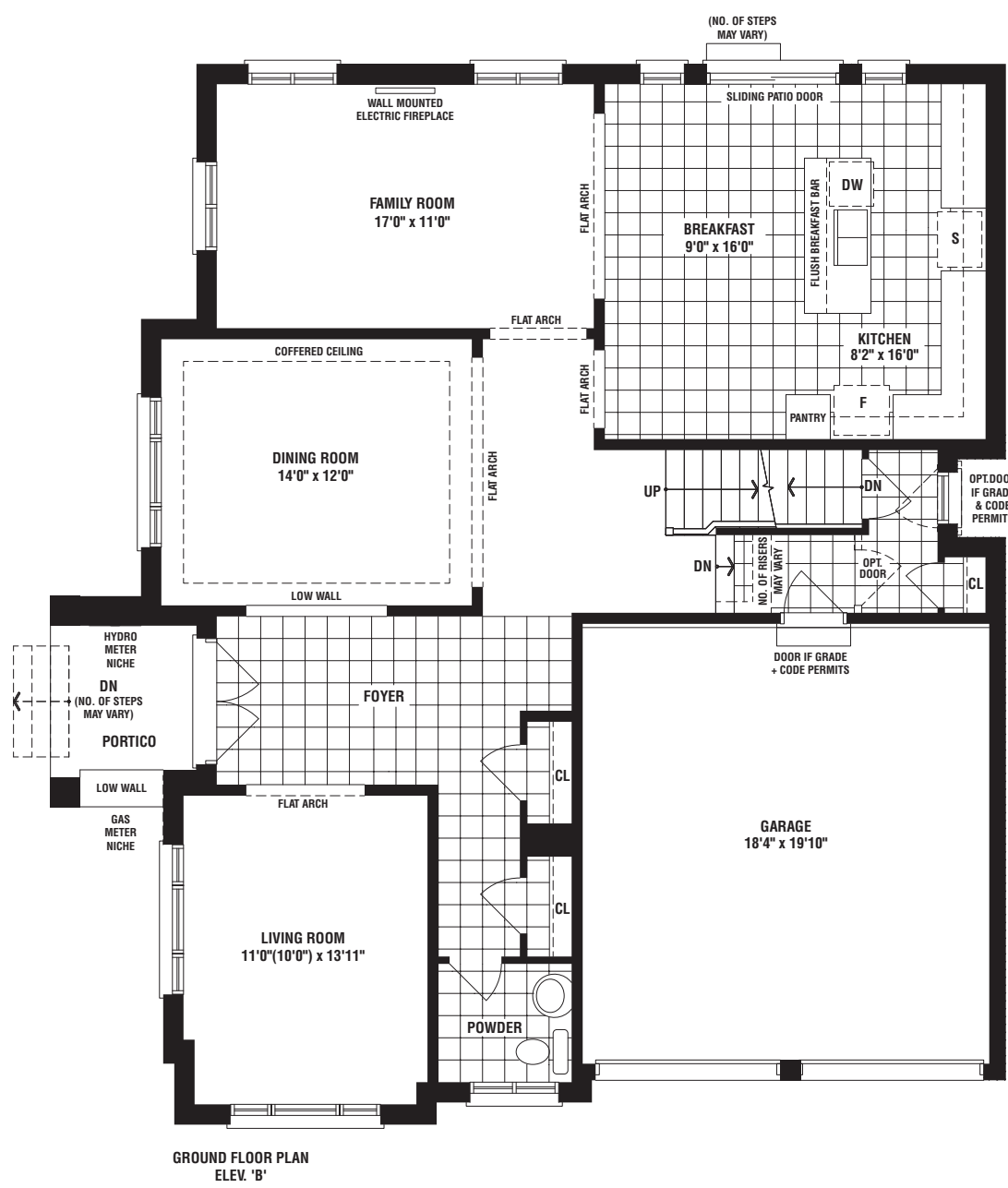
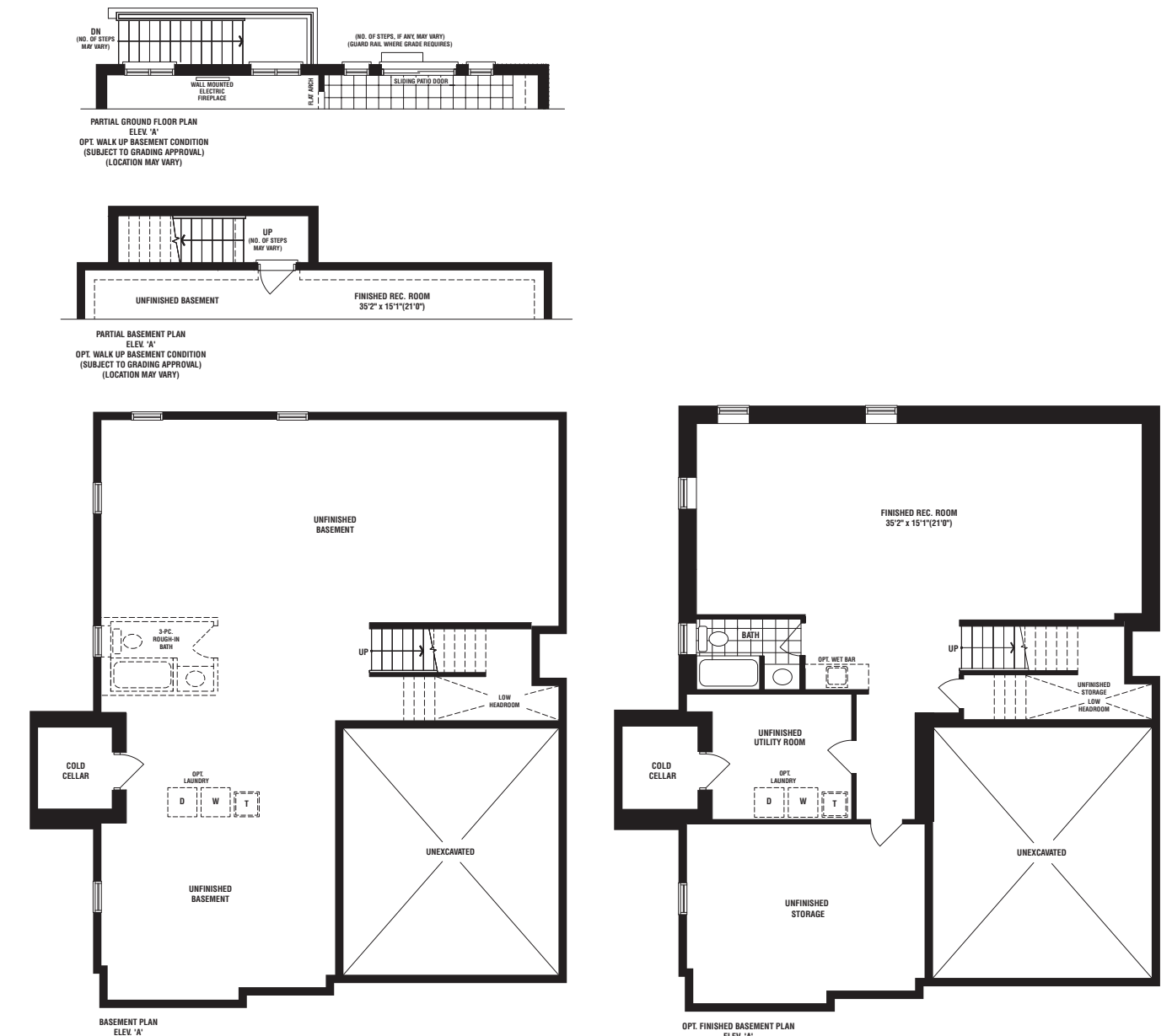
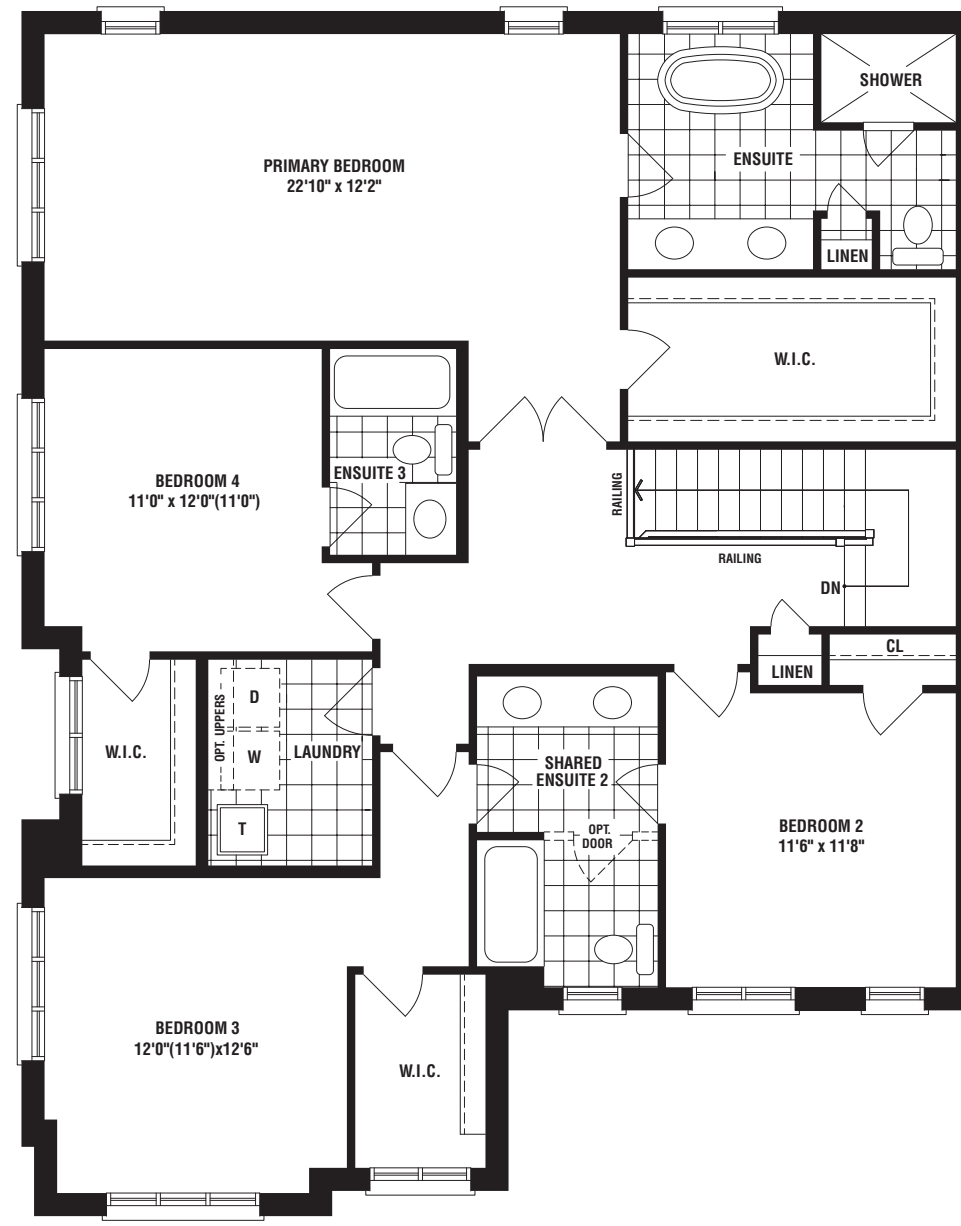
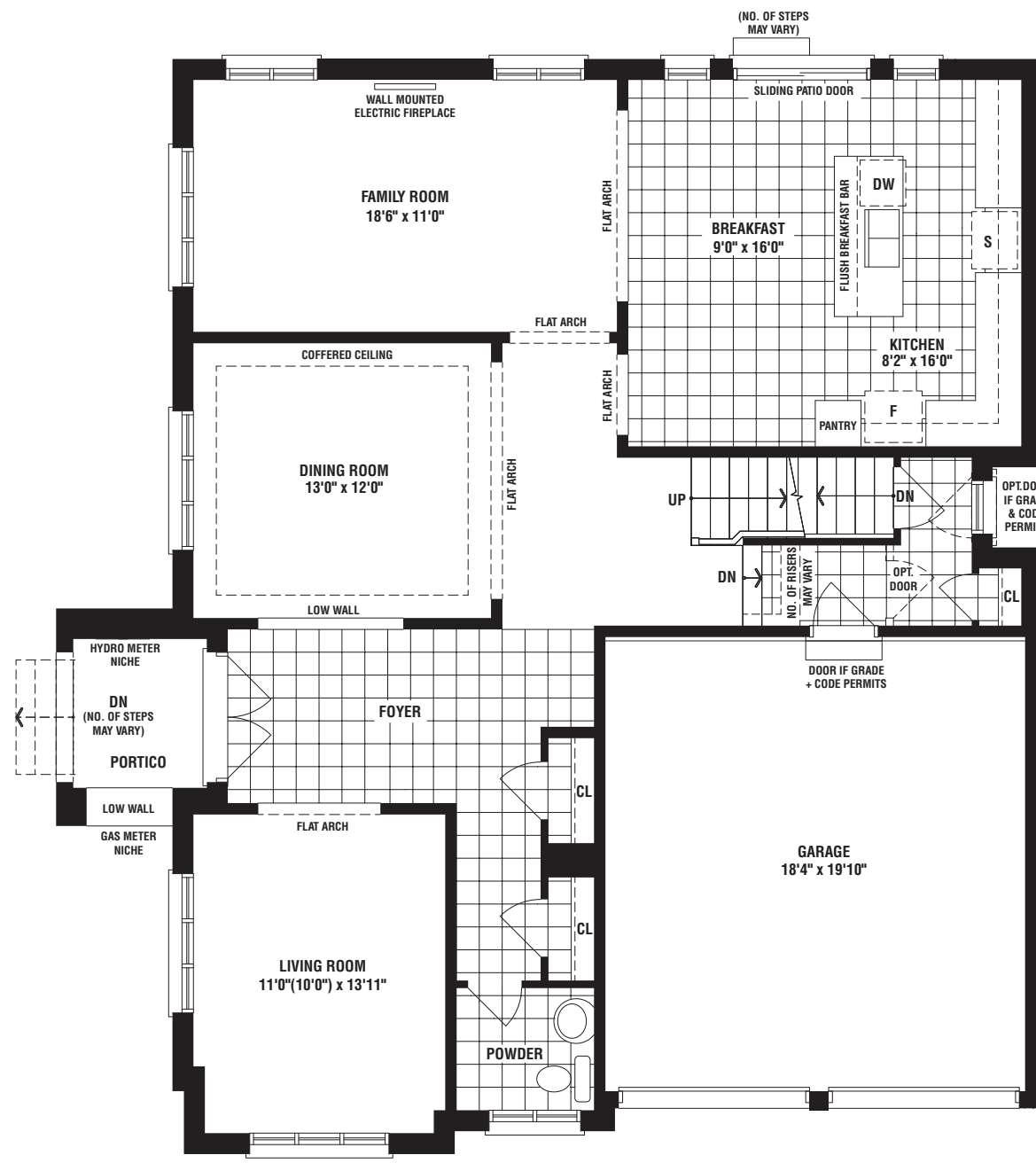

The floorplans and elevations shown, dimensions, specifications and architectural detailing are pre-construction plans and may be revised or improved as necessitated by architectural controls and the construction process. All dimensions are approximate. Actual usable floor space may vary from the stated area. House may be reversed and Purchaser agrees to accept same. Specifications subject to change without notice. Number of steps and location may vary at any exterior entrance including walk-up and walk-out basements. Illustrations are Artist's concept. Exterior railings on plans only as required by grade. E. & O. E. 08/28 A45-7C

UPPER EAST SIDE  
**UNIONVILLE**

**UPLANDS**

ELEV A • 3003 SQ. FT.

ELEV B • 3008 SQ. FT.



45'

FIELDGATEHOMES.COM



45'

UPPER EAST SIDE  
**UNIONVILLE**

**UPLANDS**

ELEV A • 3003 SQ. FT.

ELEV B • 3008 SQ. FT.



FIELDGATEHOMES.COM



FIELDGATEHOMES.COM

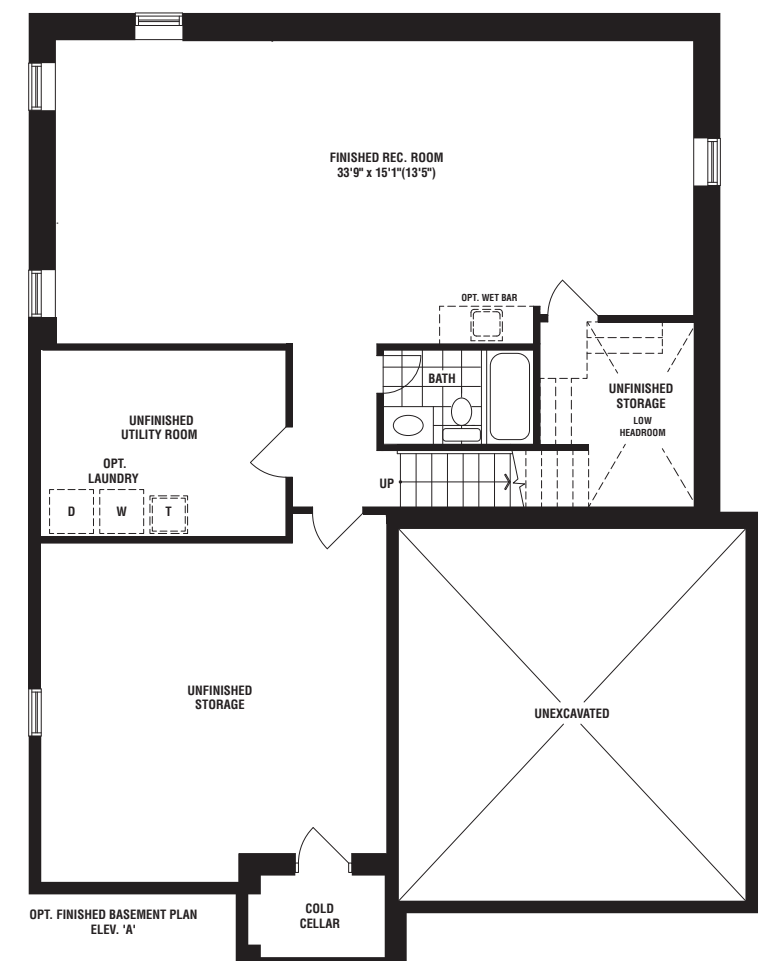
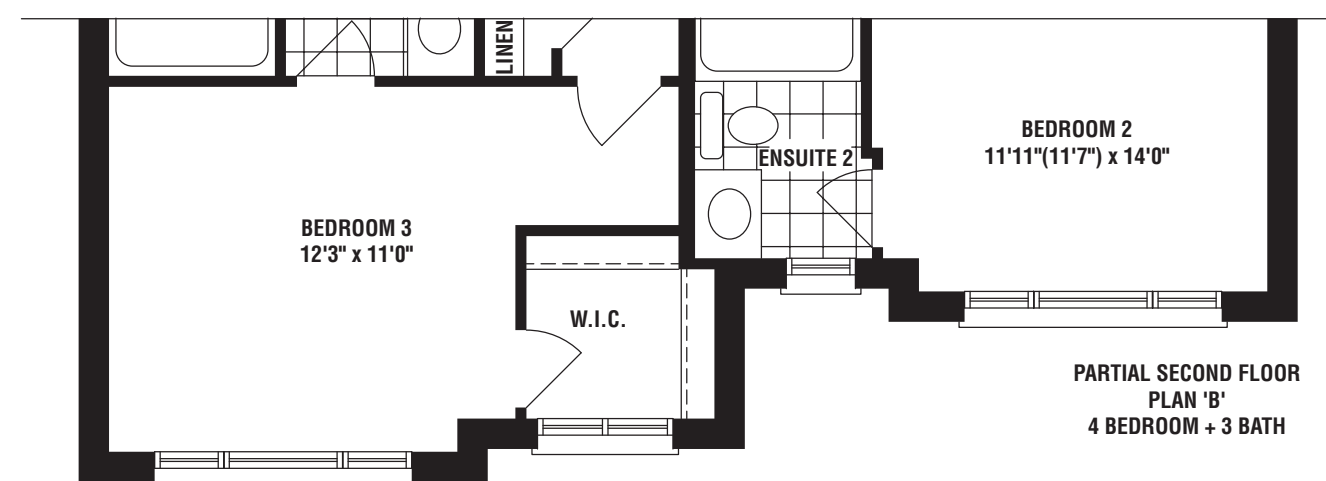
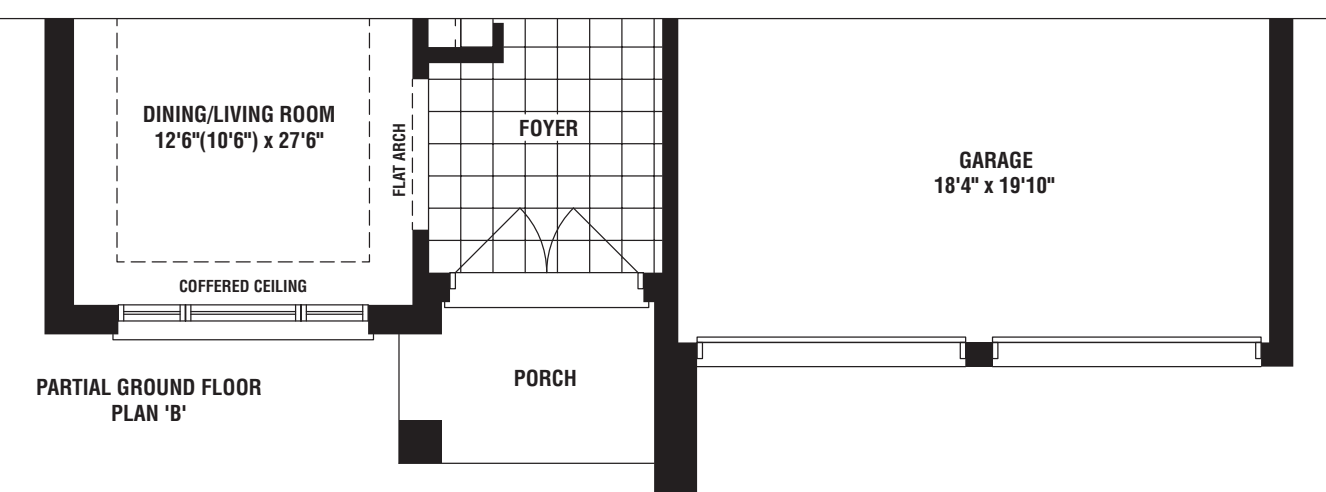
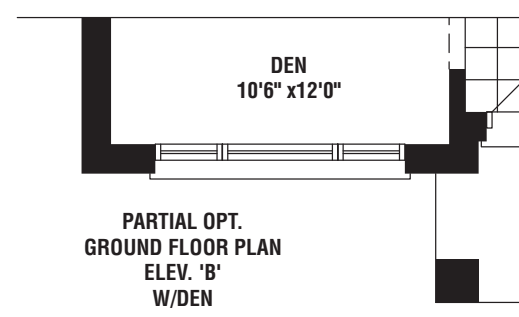
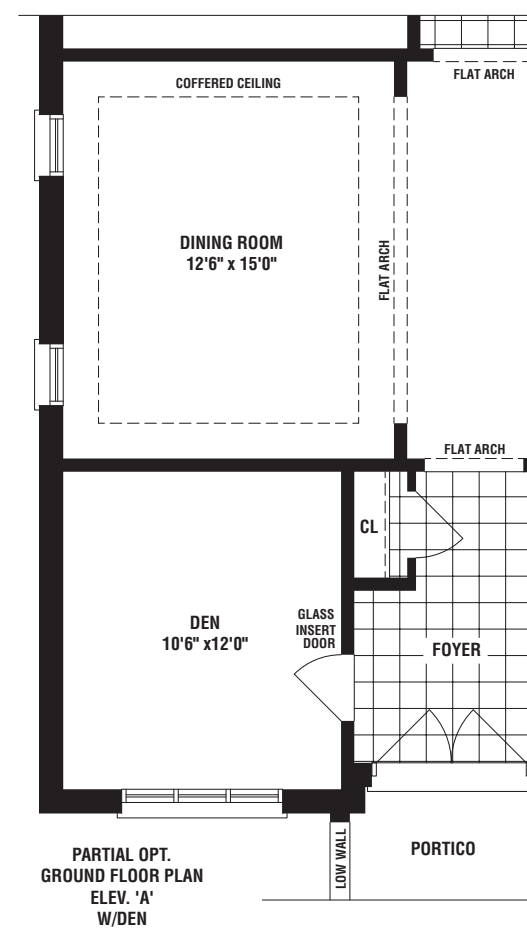
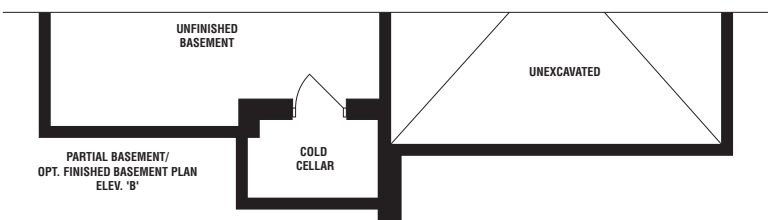
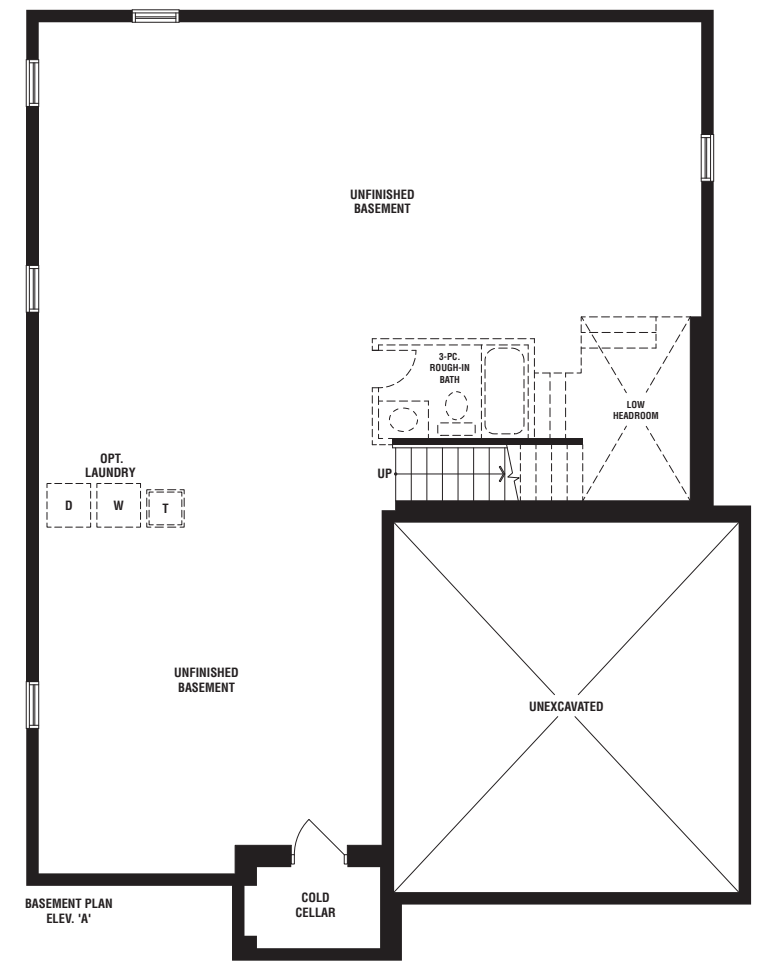
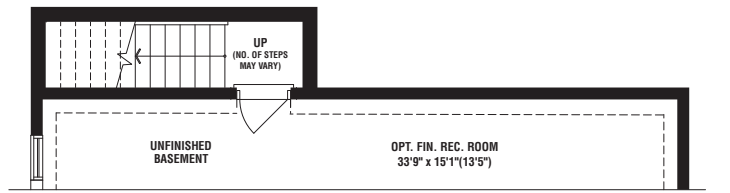
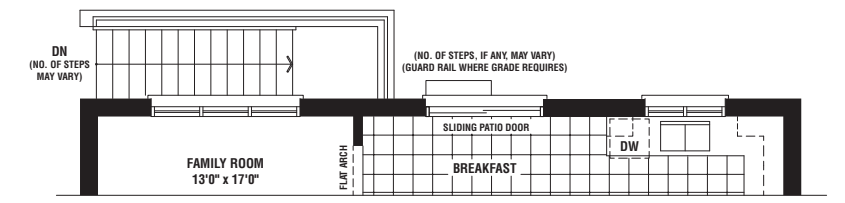
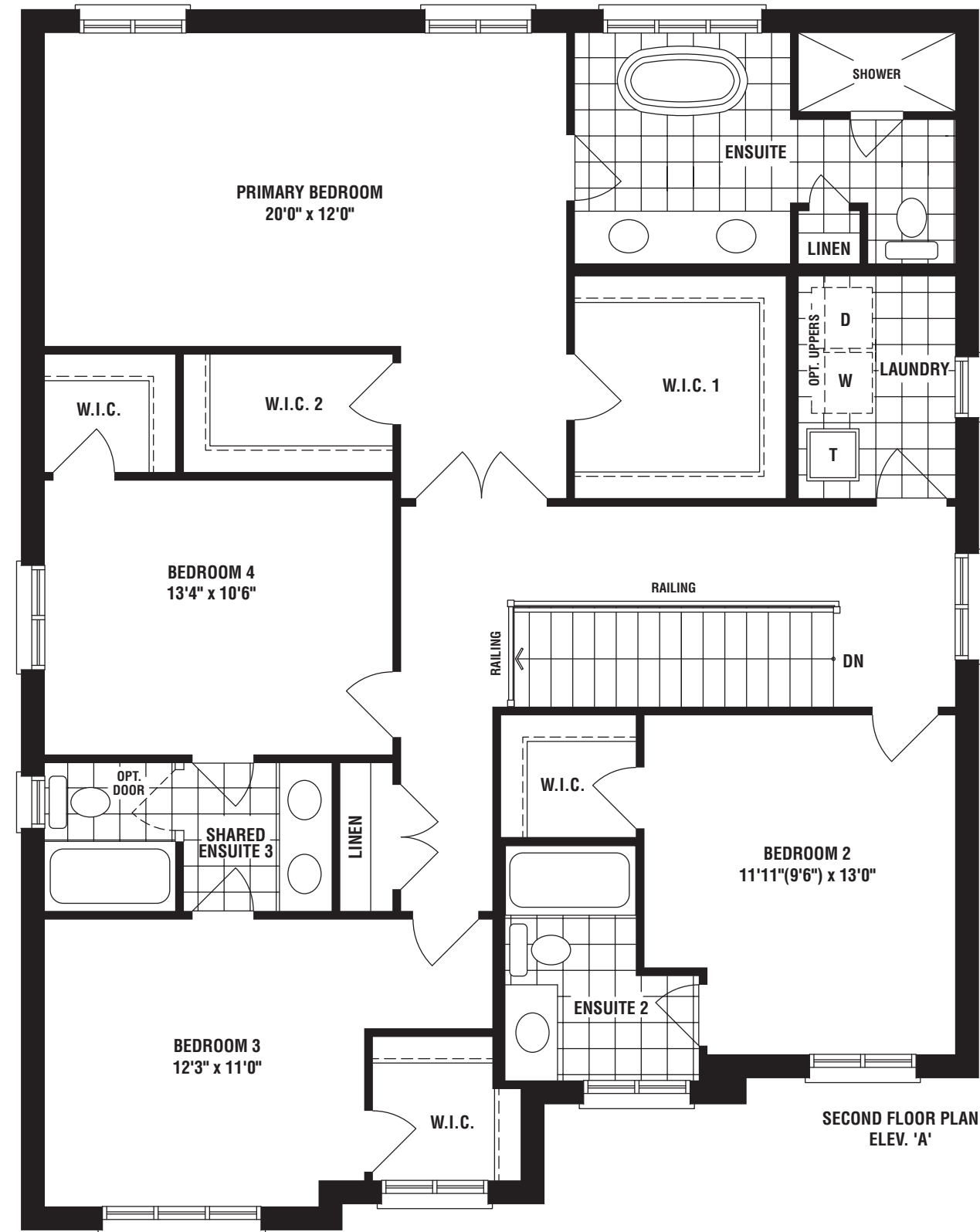
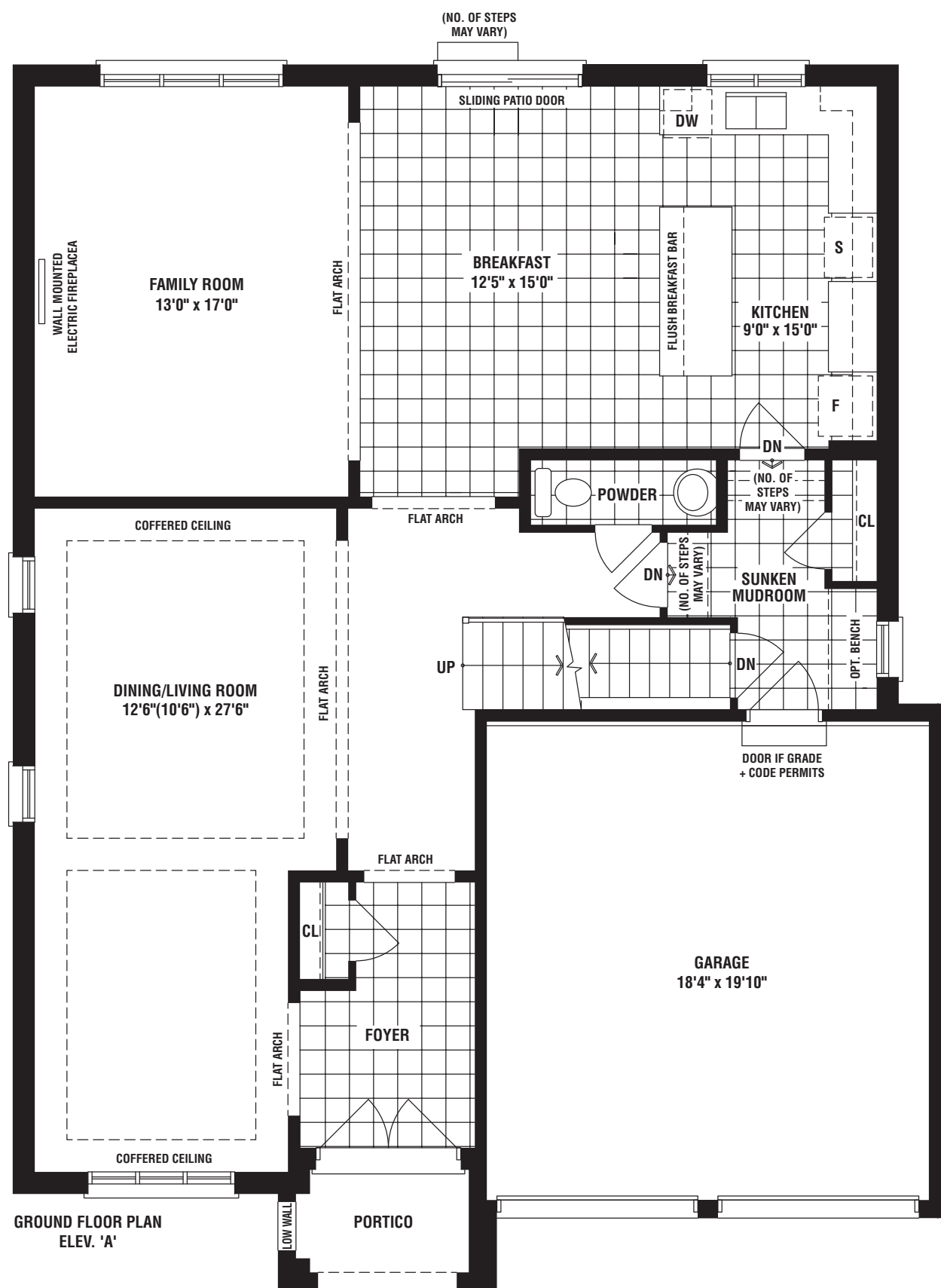

B



UPPER EAST SIDE  
**UNIONVILLE**

**LUSHLAND**

ELEV B • 3349 SQ. FT.



45'

A



UPPER EAST SIDE  
**UNIONVILLE**

**LUSHLAND**

ELEV A • 3347 SQ. FT.



45'

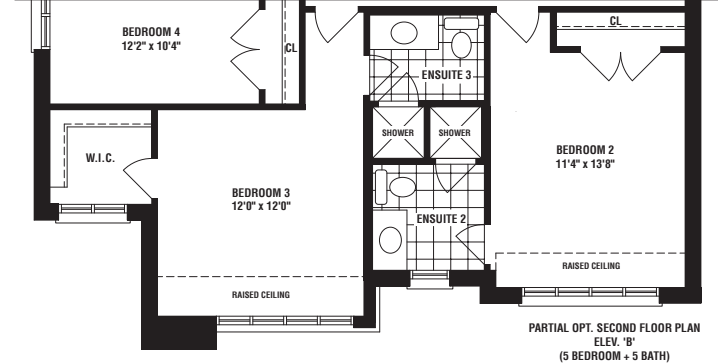
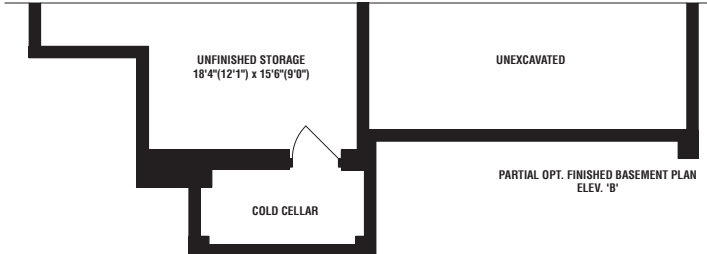
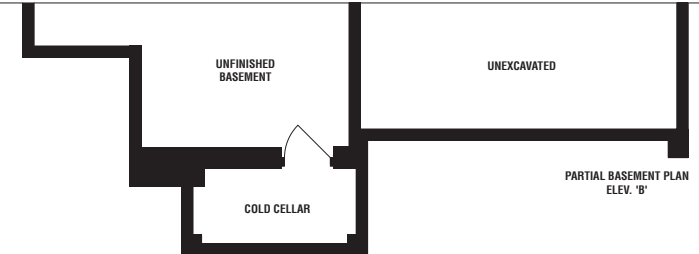
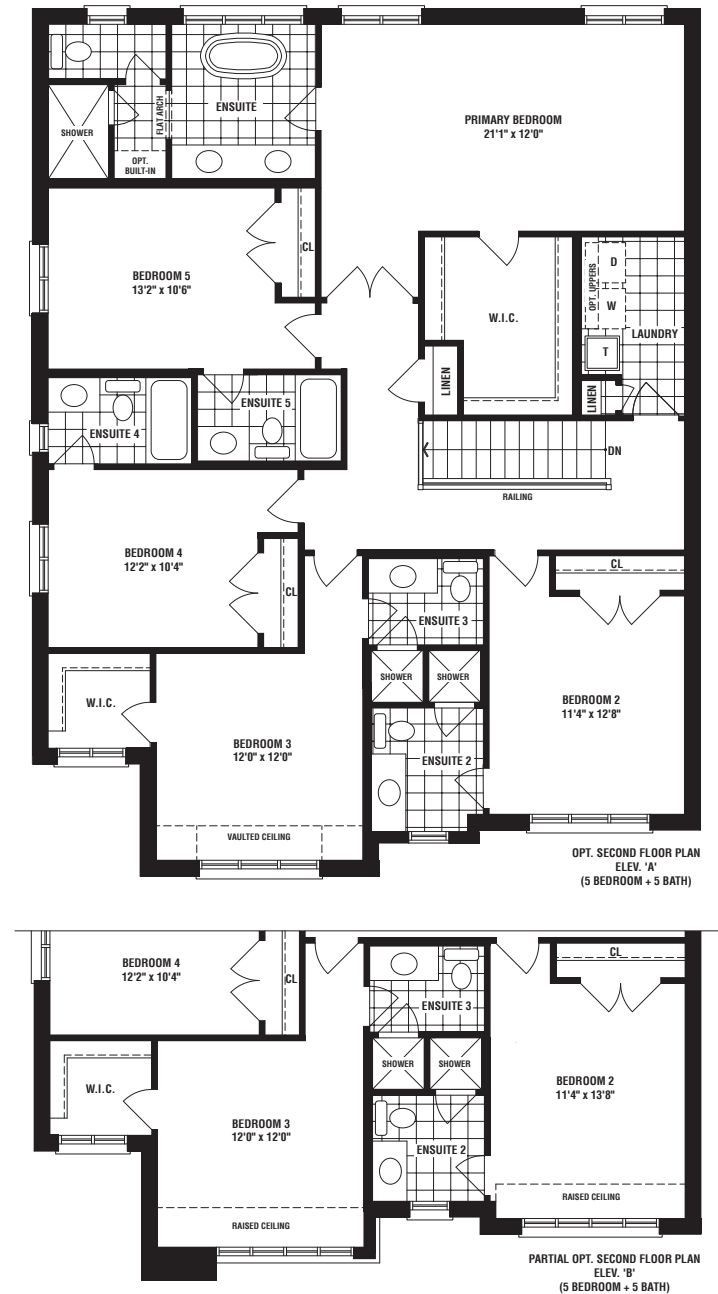
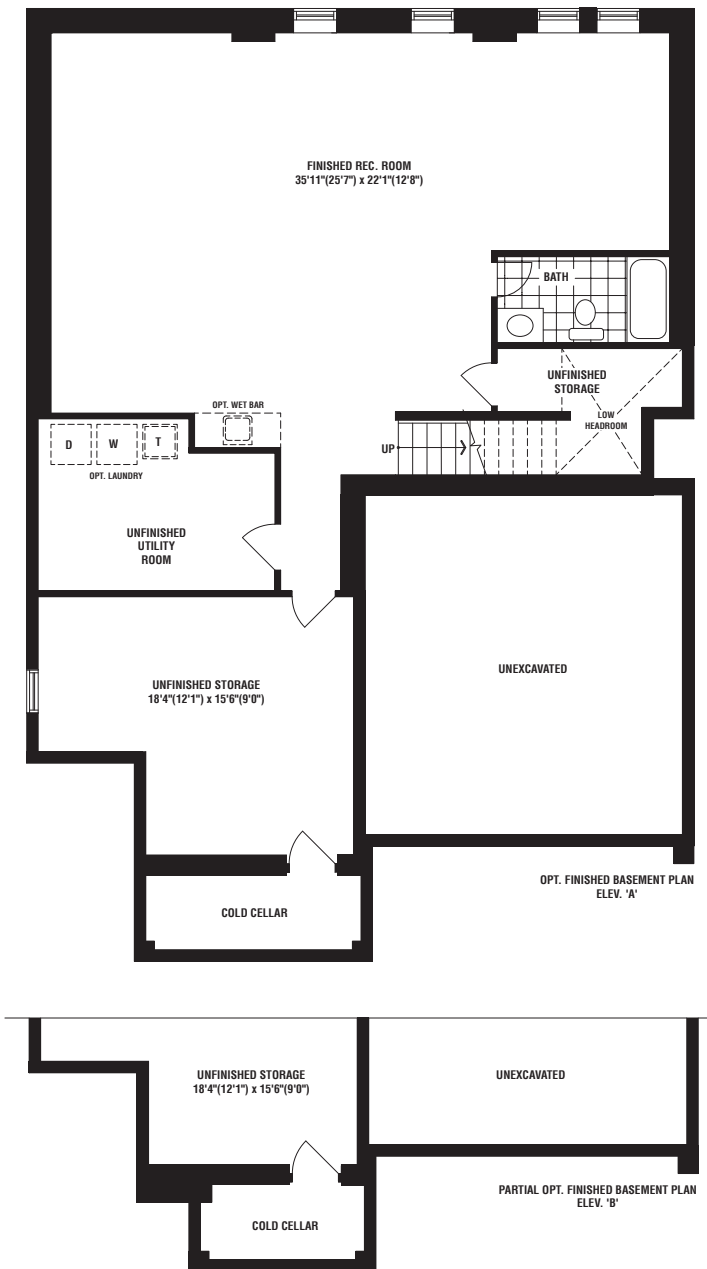
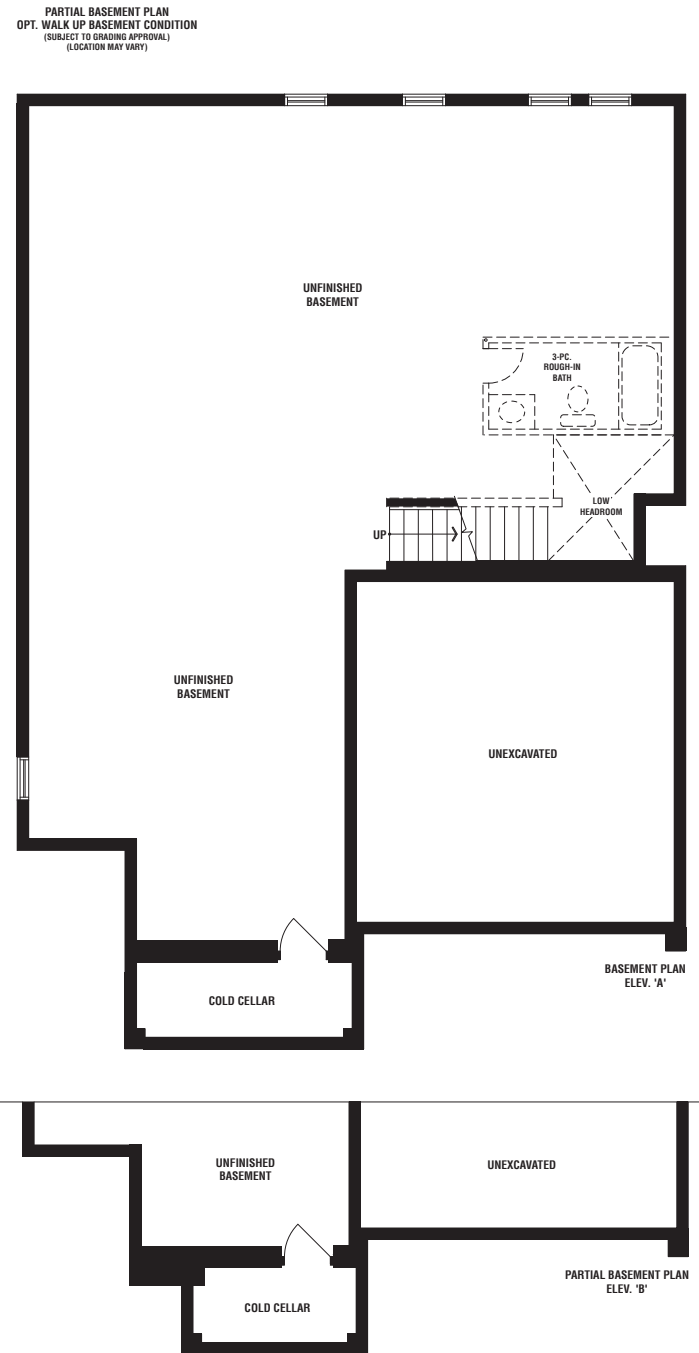
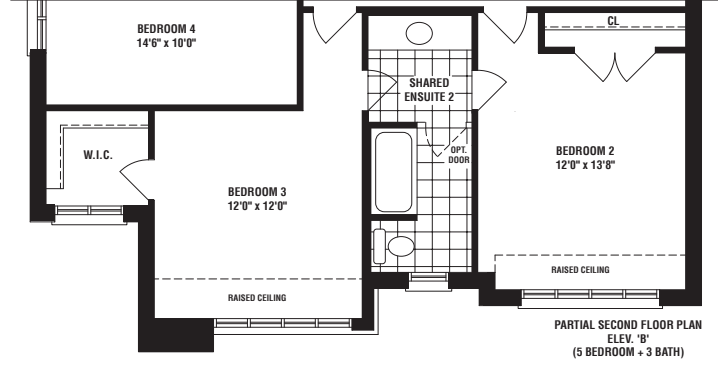
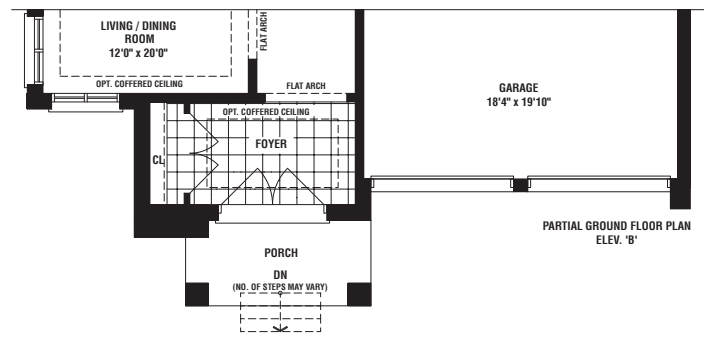
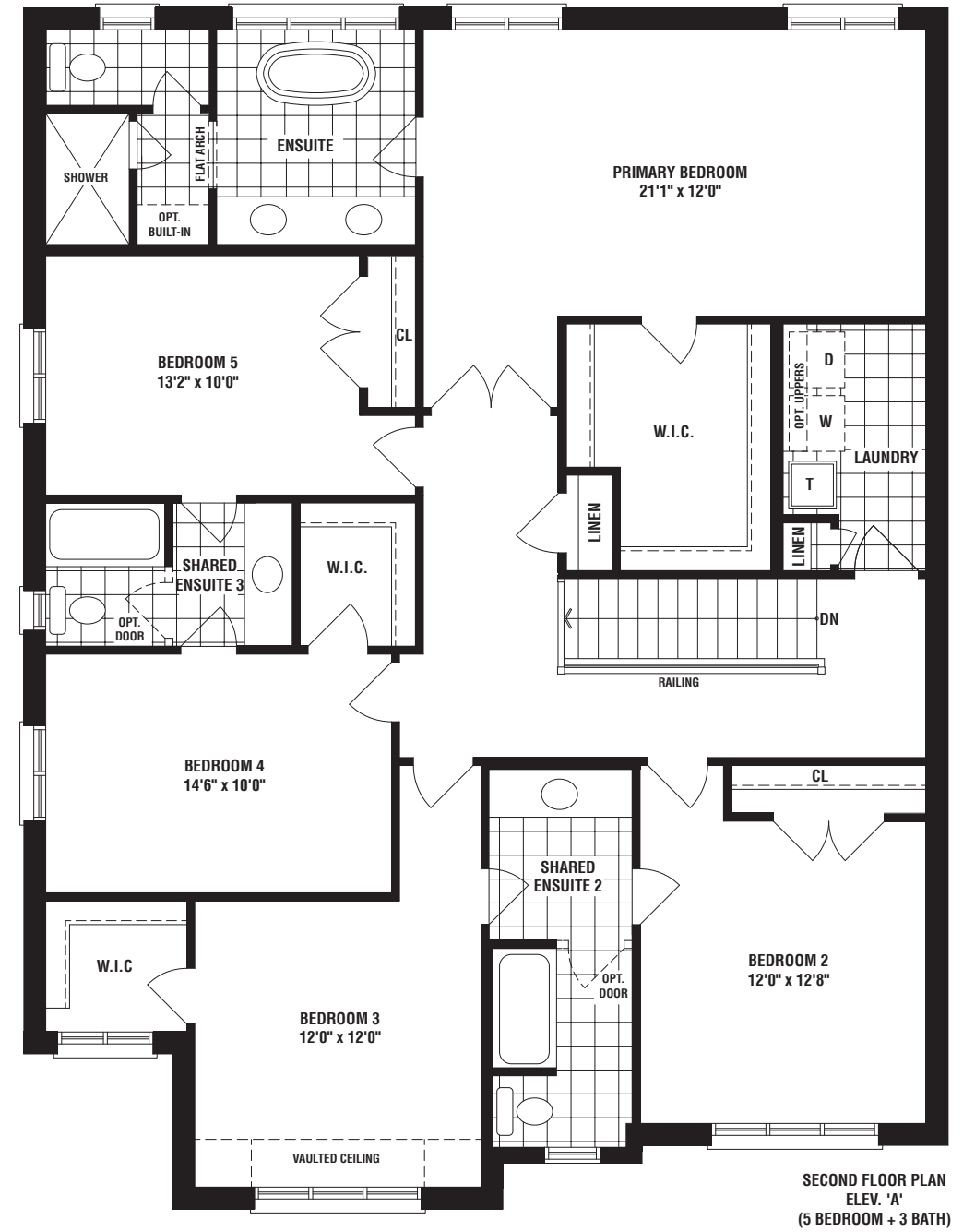
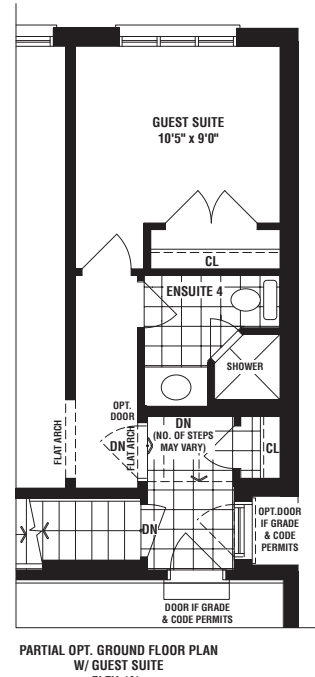
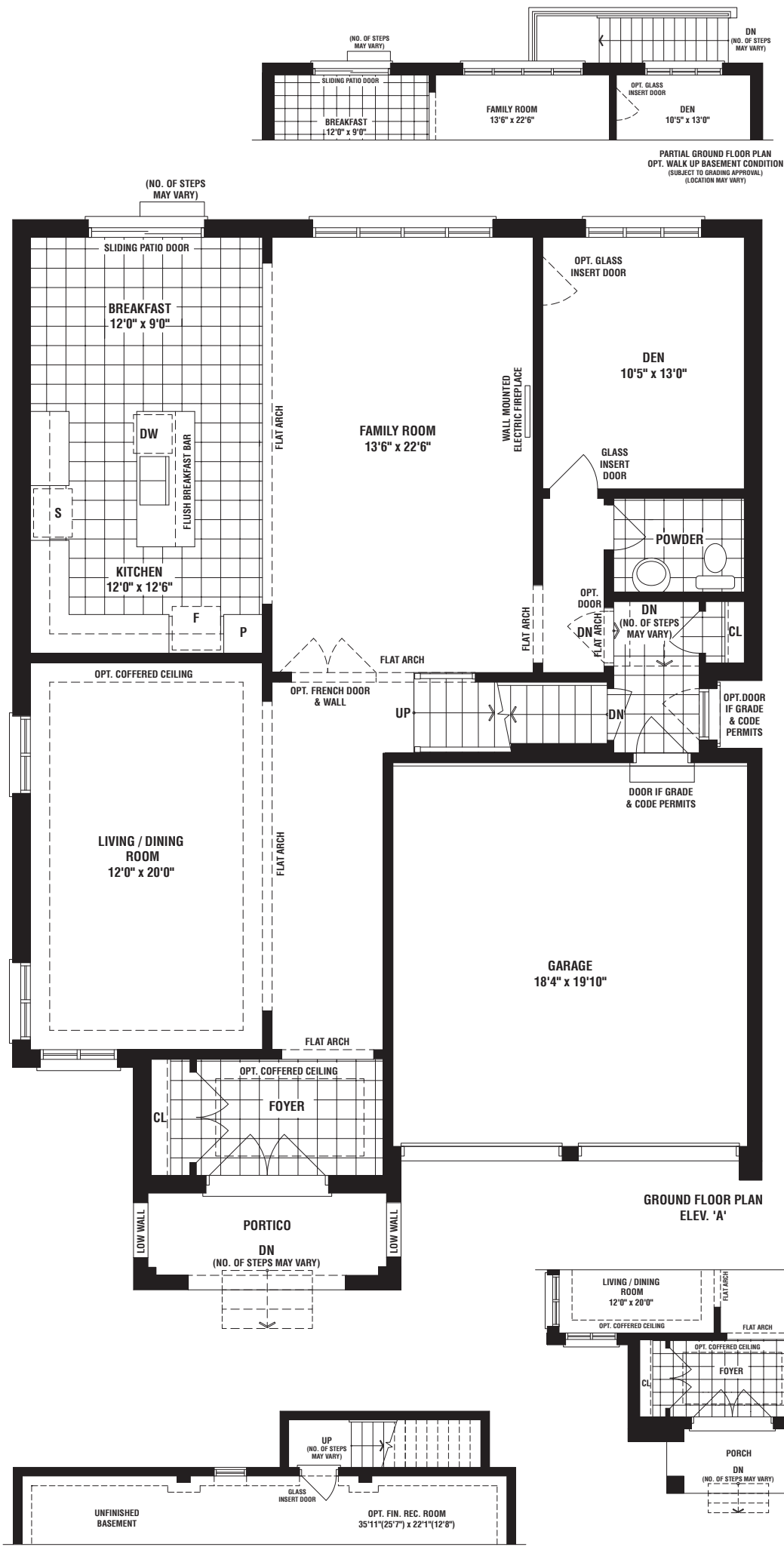

B



UPPER EAST SIDE  
**UNIONVILLE**

**MEADOWS**

ELEV B • 3535 SQ. FT.



OVER 65 YEARS OF EXCELLENCE

45'

A



UPPER EAST SIDE  
**UNIONVILLE**

**MEADOWS**

ELEV A • 3533 SQ. FT.



OVER 65 YEARS OF EXCELLENCE

45'

ARTIST CONCEPT

ARTIST CONCEPT

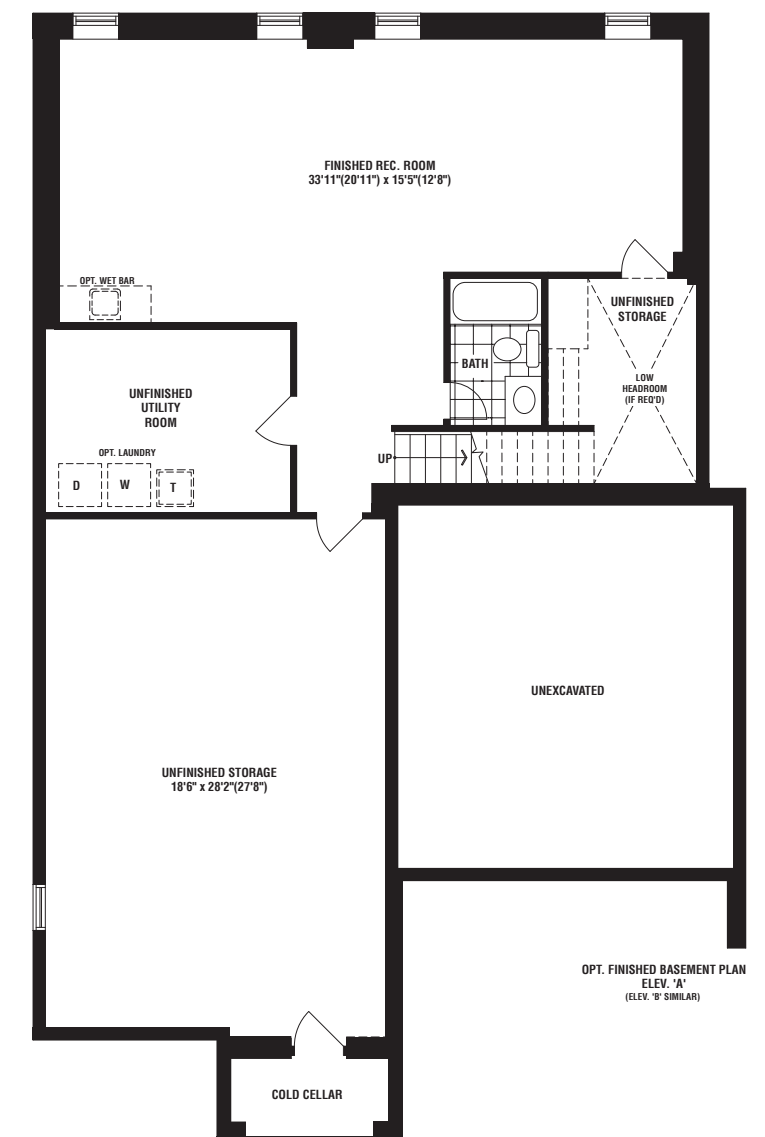
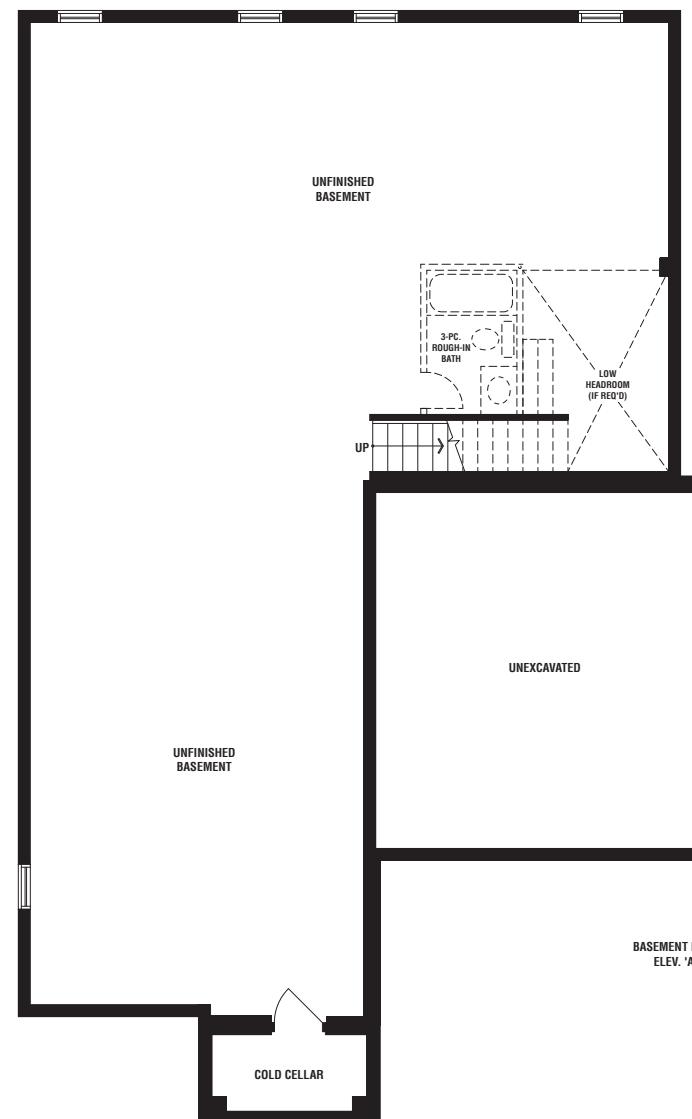
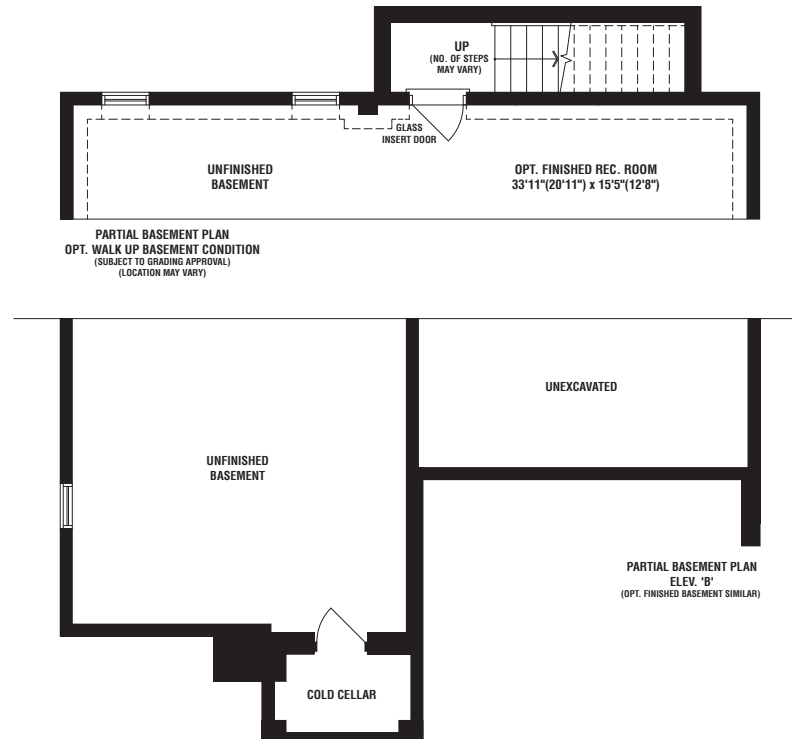
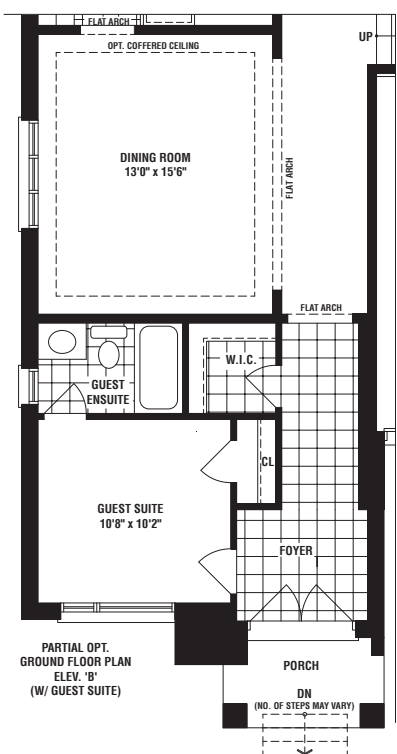
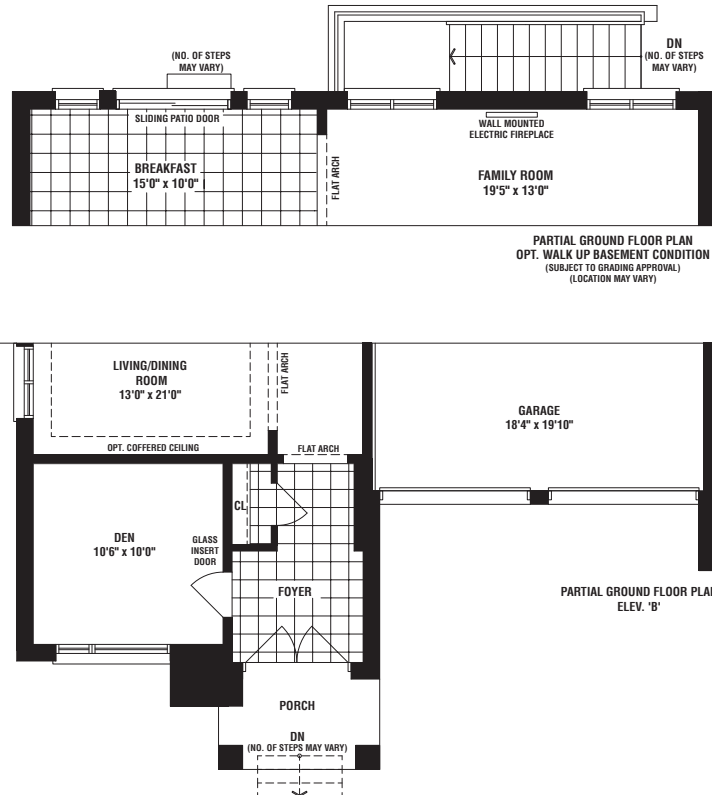
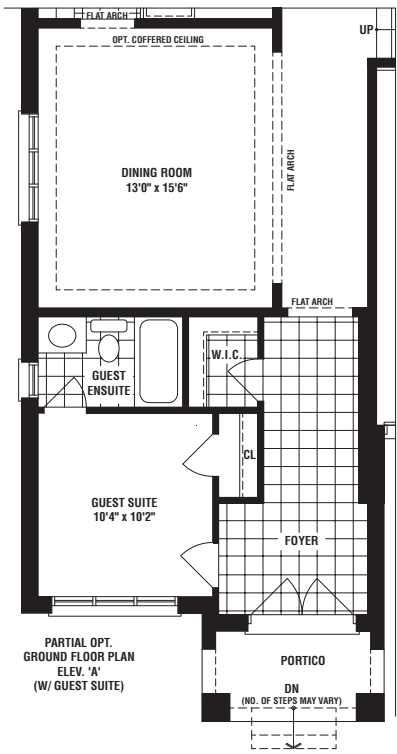
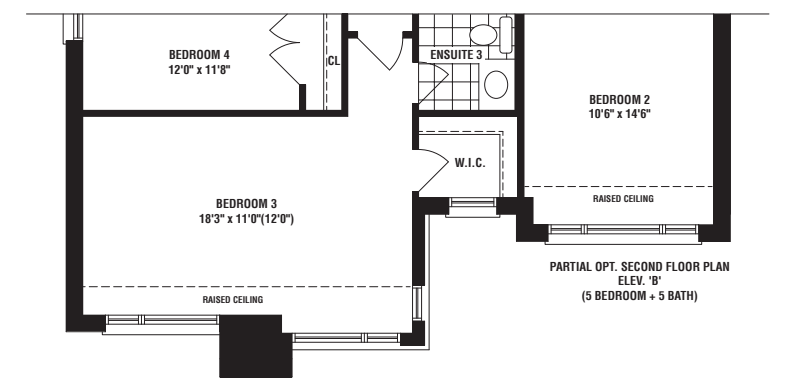
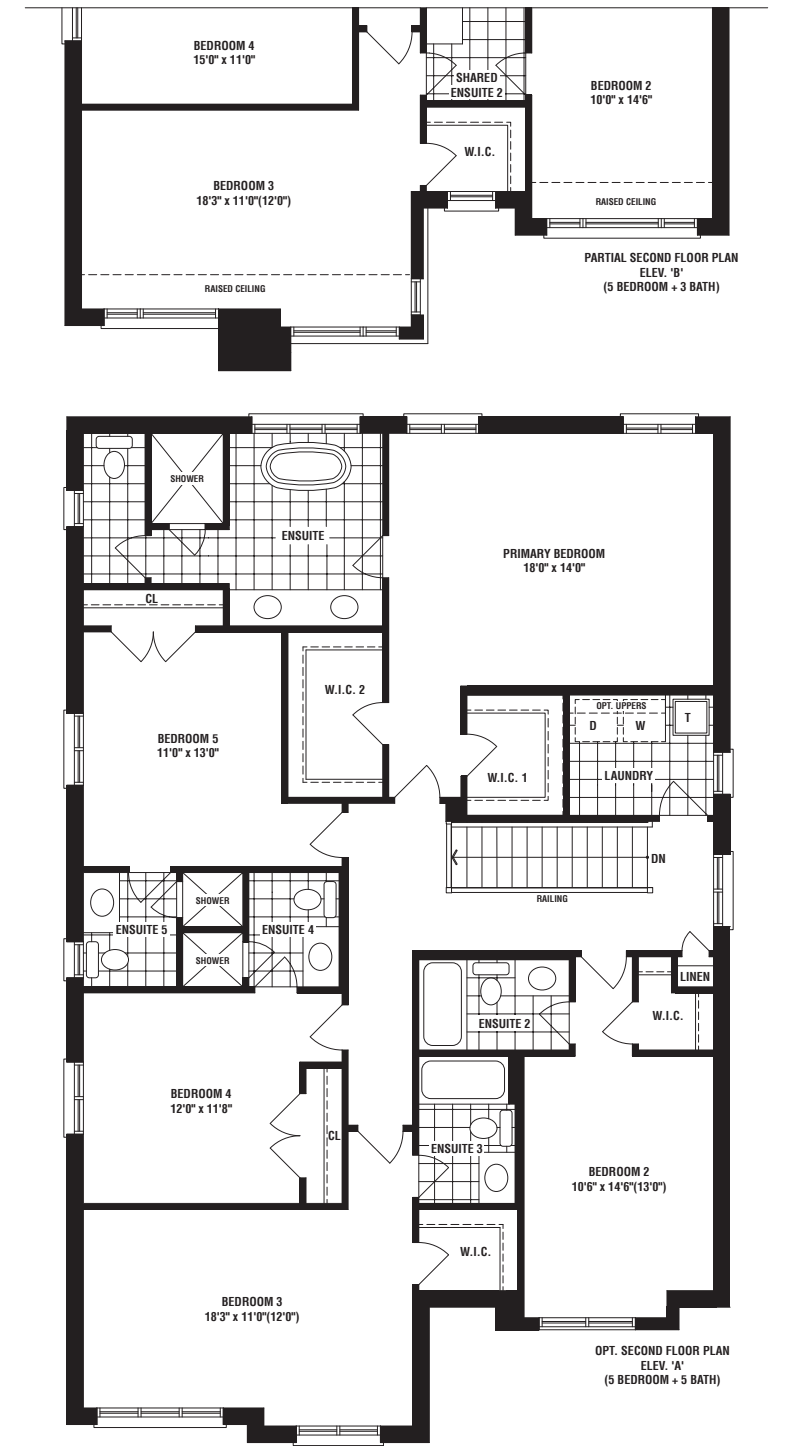
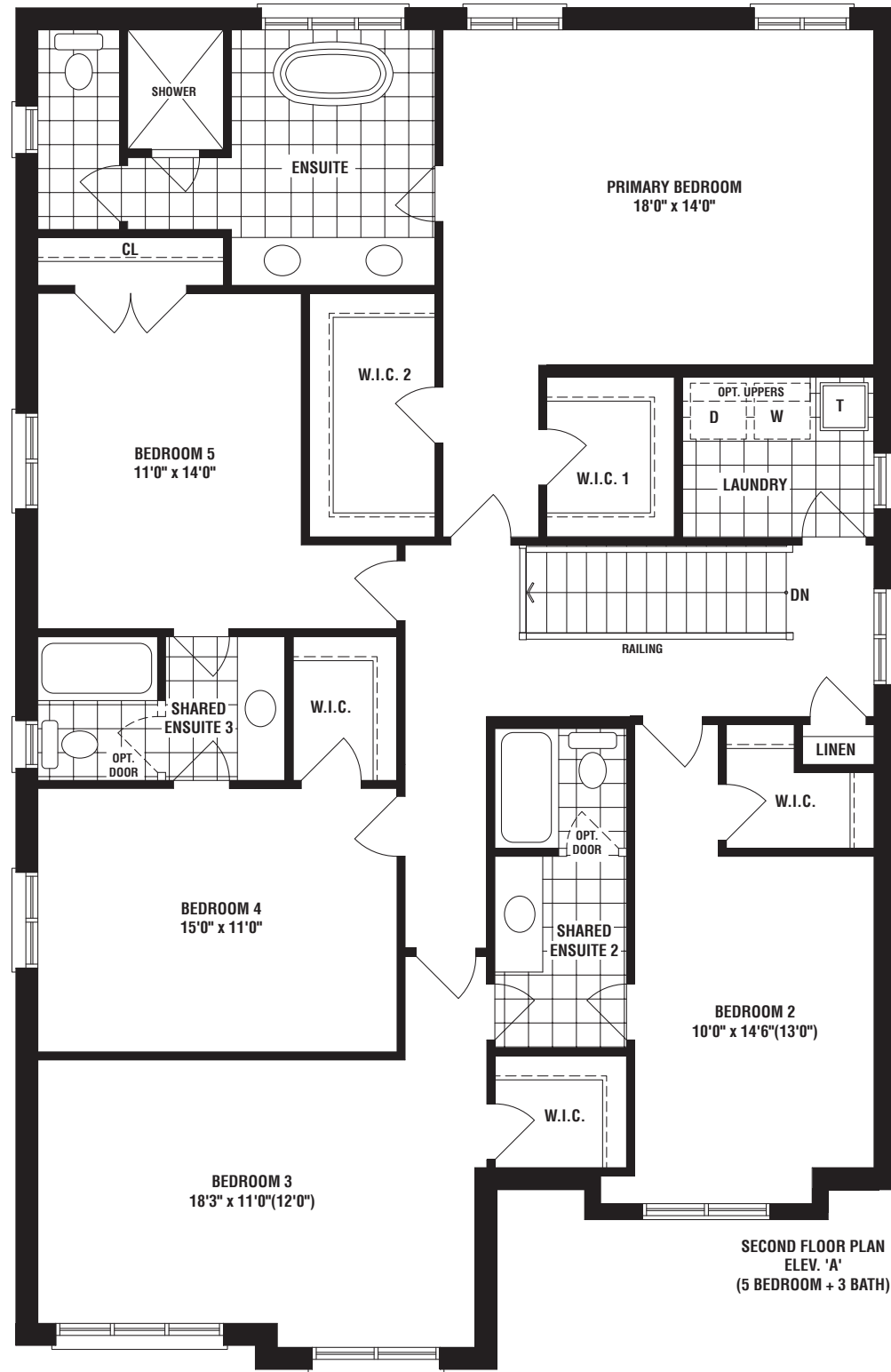
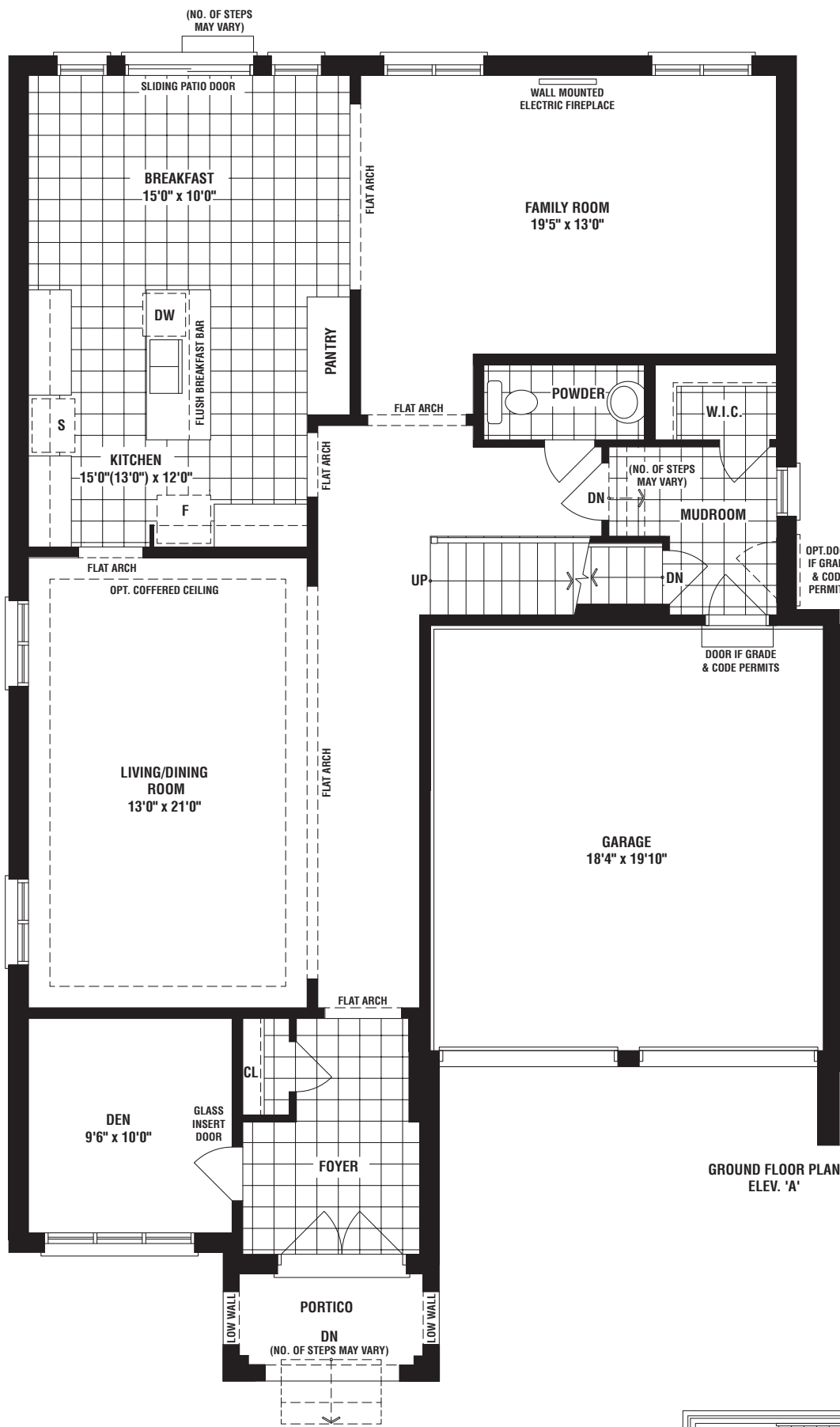

UPPER EAST SIDE  
**UNIONVILLE**

**HEATH**

ELEV B • 3562 SQ. FT.

ELEV C • 3583 SQ. FT.



45'

FIELDGATEHOMES.COM



FIELDGATEHOMES.COM

UPPER EAST SIDE  
**UNIONVILLE**

**HEATH**

ELEV A • 3573 SQ. FT.



45'

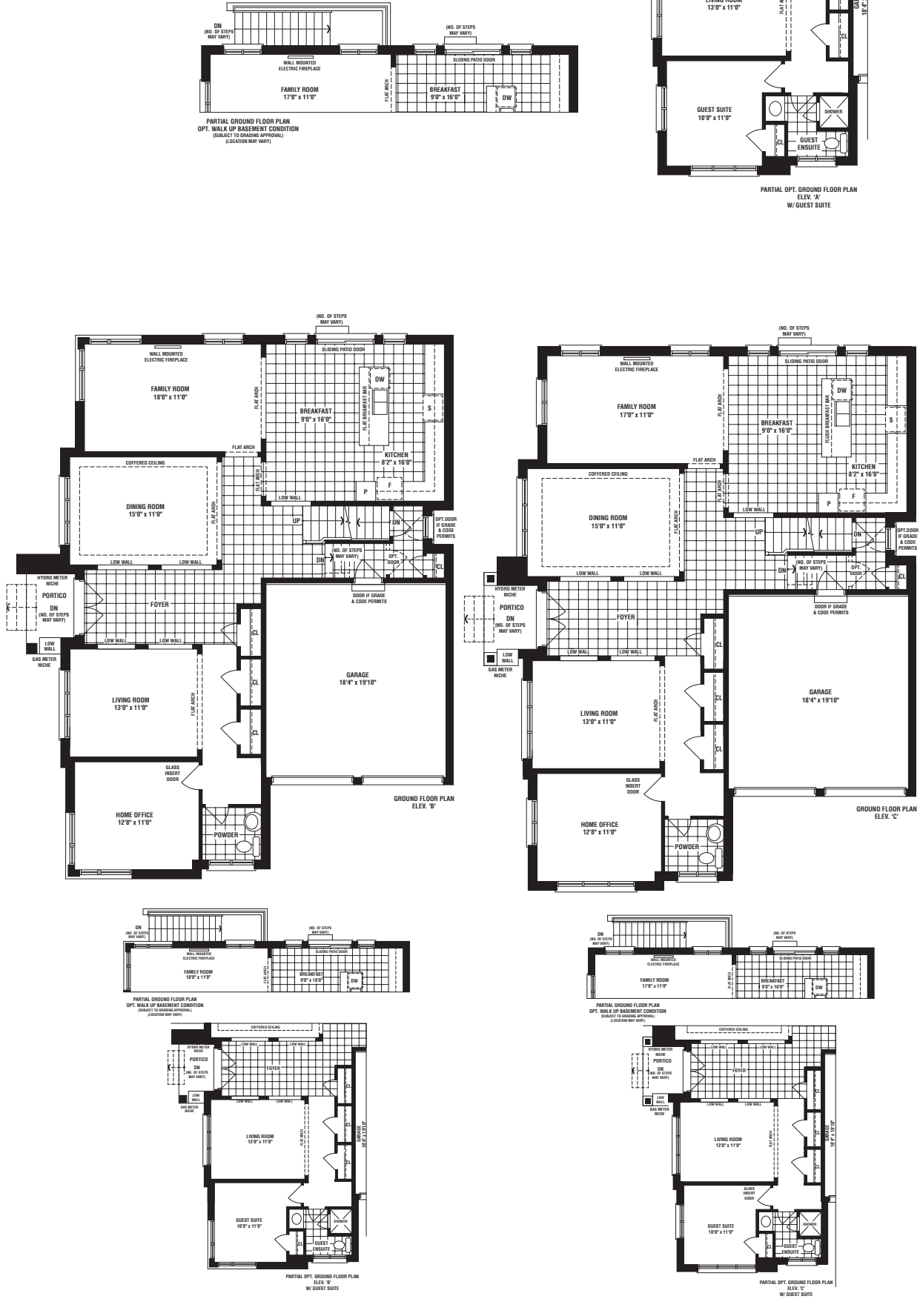
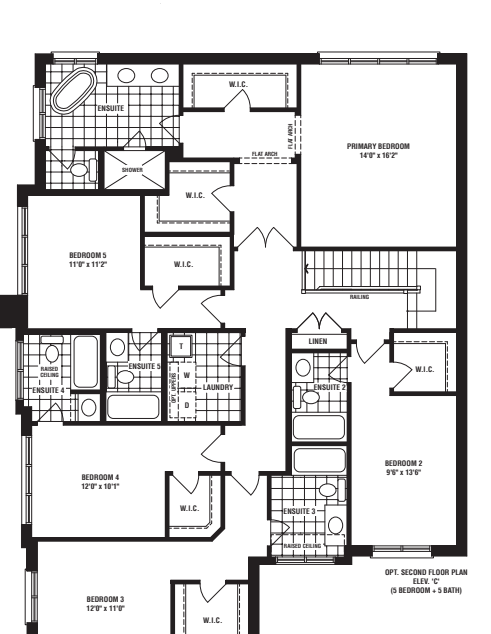
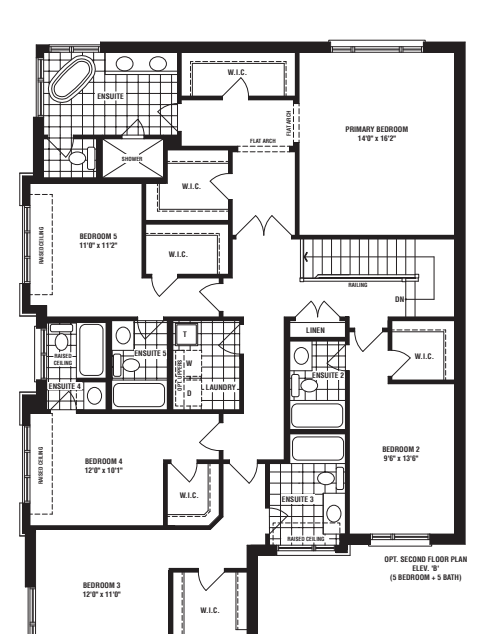
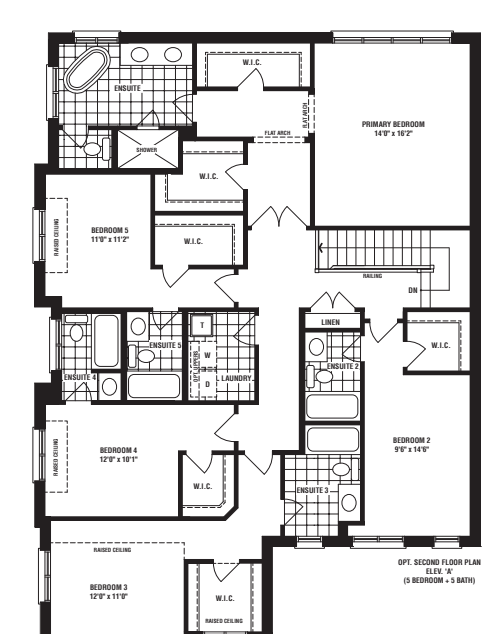
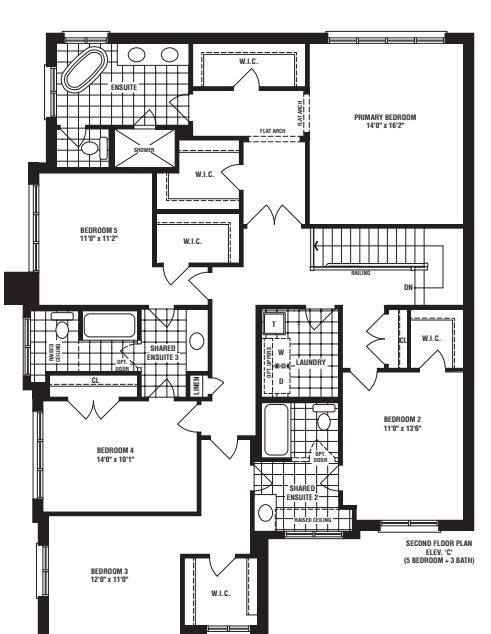
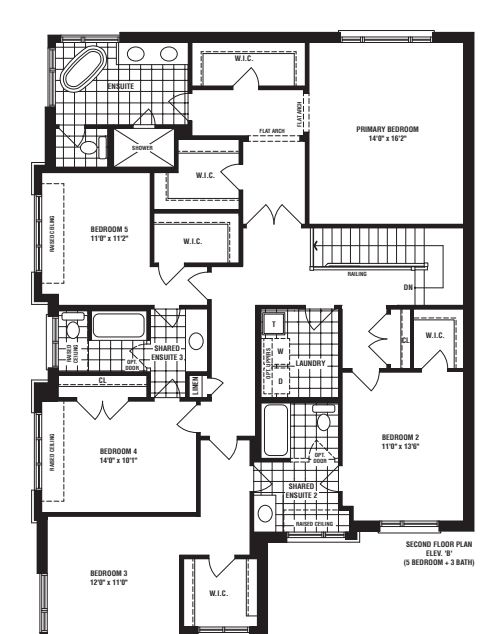
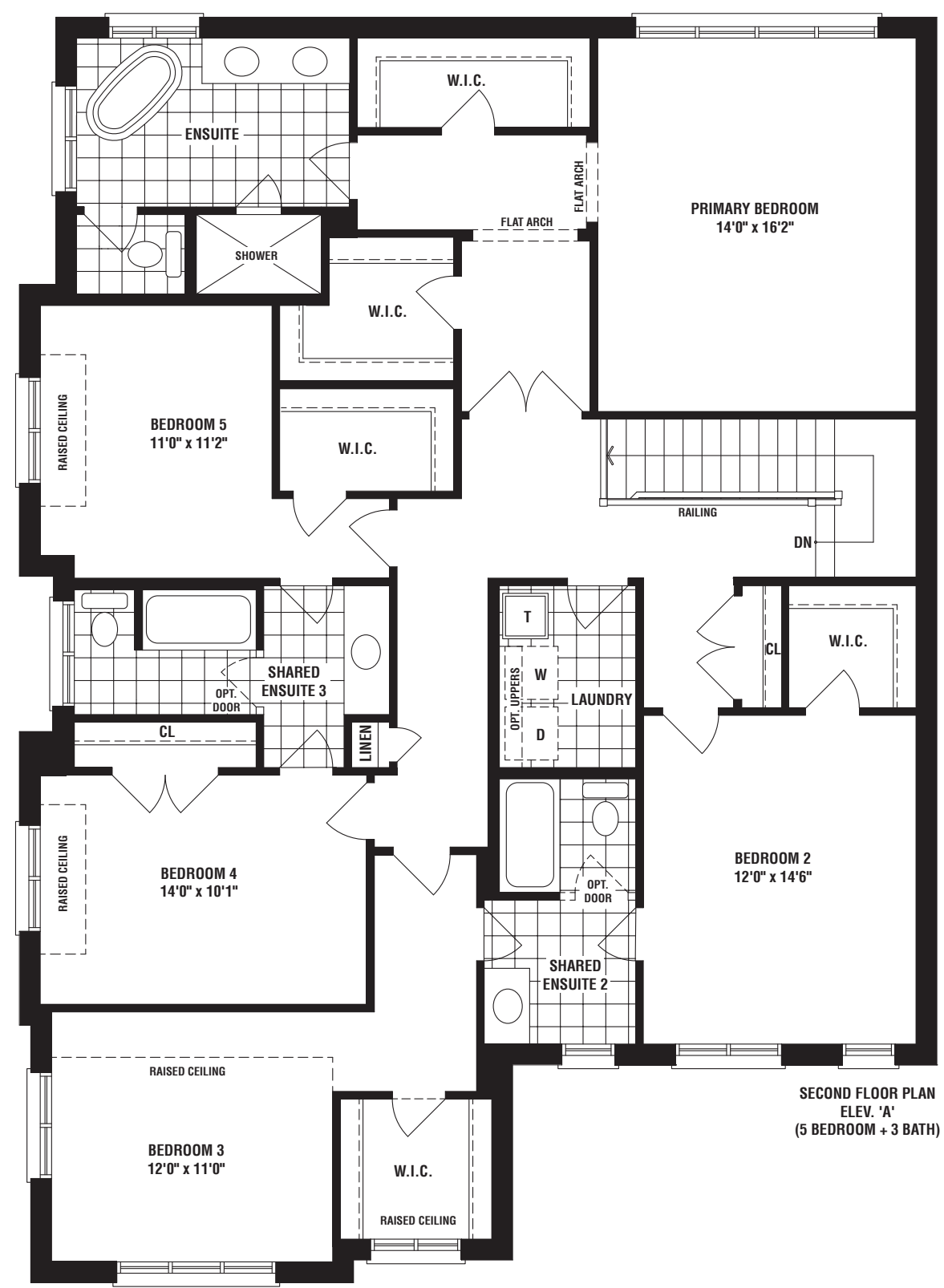
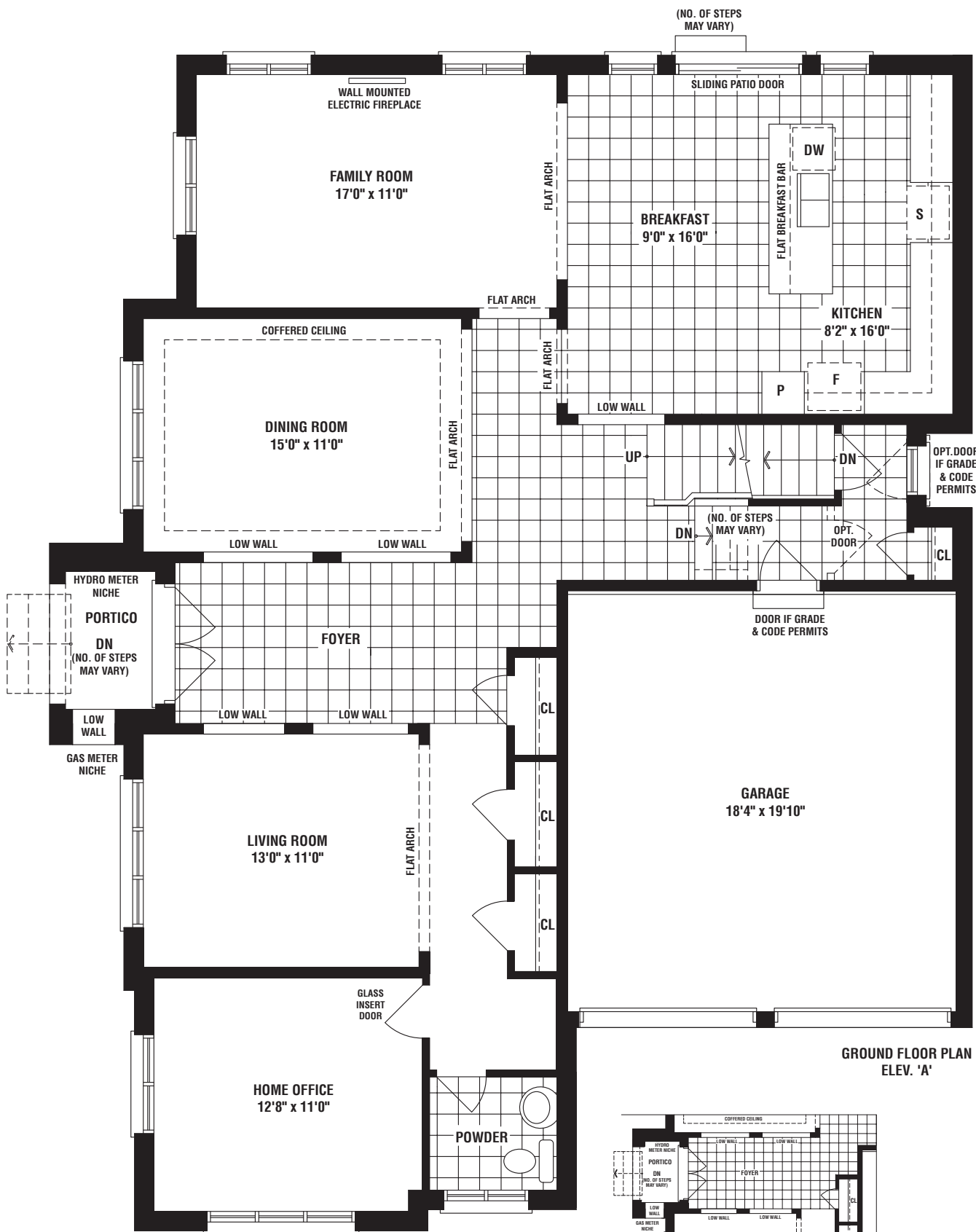

B



UPPER EAST SIDE  
**UNIONVILLE**

**PARKLAND**

ELEV B • 3716 SQ. FT.



OVER 65 YEARS OF EXCELLENCE

45'

A



UPPER EAST SIDE  
**UNIONVILLE**

**PARKLAND**

ELEV A • 3716 SQ. FT.



OVER 65 YEARS OF EXCELLENCE

45'

ARTIST CONCEPT

ARTIST CONCEPT

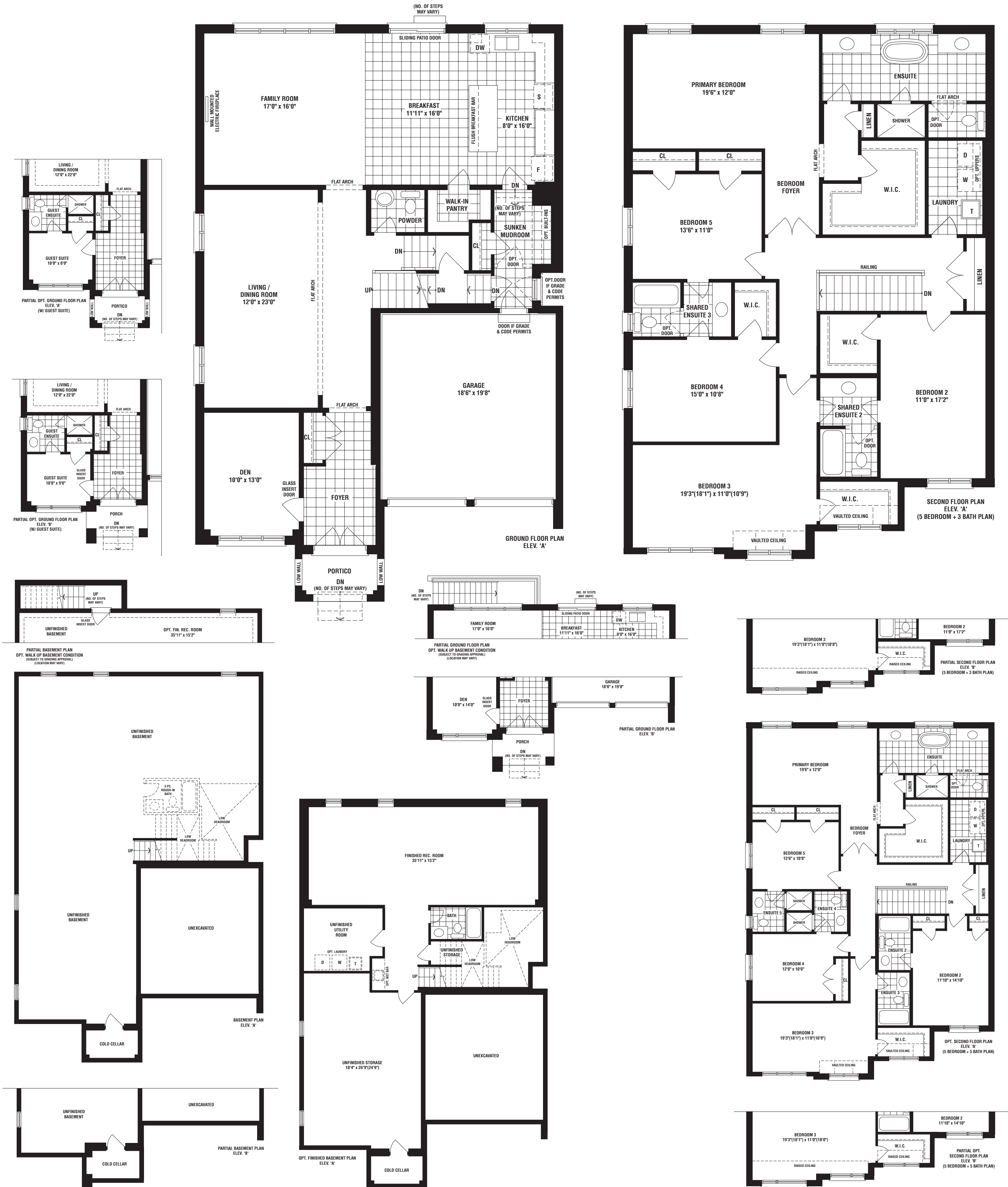

B



UPPER EAST SIDE  
**UNIONVILLE**

LANDSCAPE

ELEV B • 3904 SQ. FT.



45'

A



UPPER EAST SIDE  
**UNIONVILLE**

LANDSCAPE

ELEV A • 3911 SQ. FT.



45'

ARTIST CONCEPT

ARTIST CONCEPT

